

Slow, Fast, and “Backwards” Light: Fundamentals and Applications

Robert W. Boyd

Institute of Optics and
Department of Physics and Astronomy
University of Rochester

www.optics.rochester.edu/~boyd

with Yuping Chen, George Gehring, Giovanni Piredda,
Aaron Schweinsberg, Katie Schwertz, Zhimin Shi, Heedeuk Shin,
Joseph Vornehm, Petros Zerom, and many others

Presented at the University of Illinois, Urbana-Champaign, November 1, 2006.

Interest in Slow Light

Intrigue: Can (group) refractive index really be 10^6 ?

Fundamentals of optical physics

Optical delay lines, optical storage, optical memories

Implications for quantum information

What about fast light ($v > c$) and backwards light (v negative)?

Boyd and Gauthier, "Slow and Fast Light," in Progress in Optics, 43, 2002.

Group Velocity

Pulse
(wave packet)

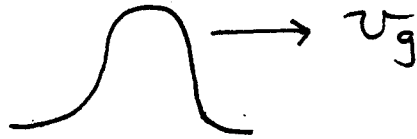

Group velocity given by $v_g = \frac{d\omega}{dk}$

$$\text{For } k = \frac{n\omega}{c} \quad \frac{dk}{d\omega} = \frac{1}{c} \left(n + \omega \frac{dn}{d\omega} \right)$$

Thus

$$v_g = \frac{c}{n + \omega \frac{dn}{d\omega}} \equiv \frac{c}{n_g}$$

Thus $n_g \neq n$ in a dispersive medium!

Dispersion of Water Waves



* from F. Bitter and H. Medicus, Fields and particles; an introduction to electromagnetic wave phenomena and quantum physics

Switch to Overheads

Extreme group velocities are simply an interference phenomenon.

Determination of the Velocity of Light

Long History in Modern Physics

Fizeau (1849) Time-of-flight method

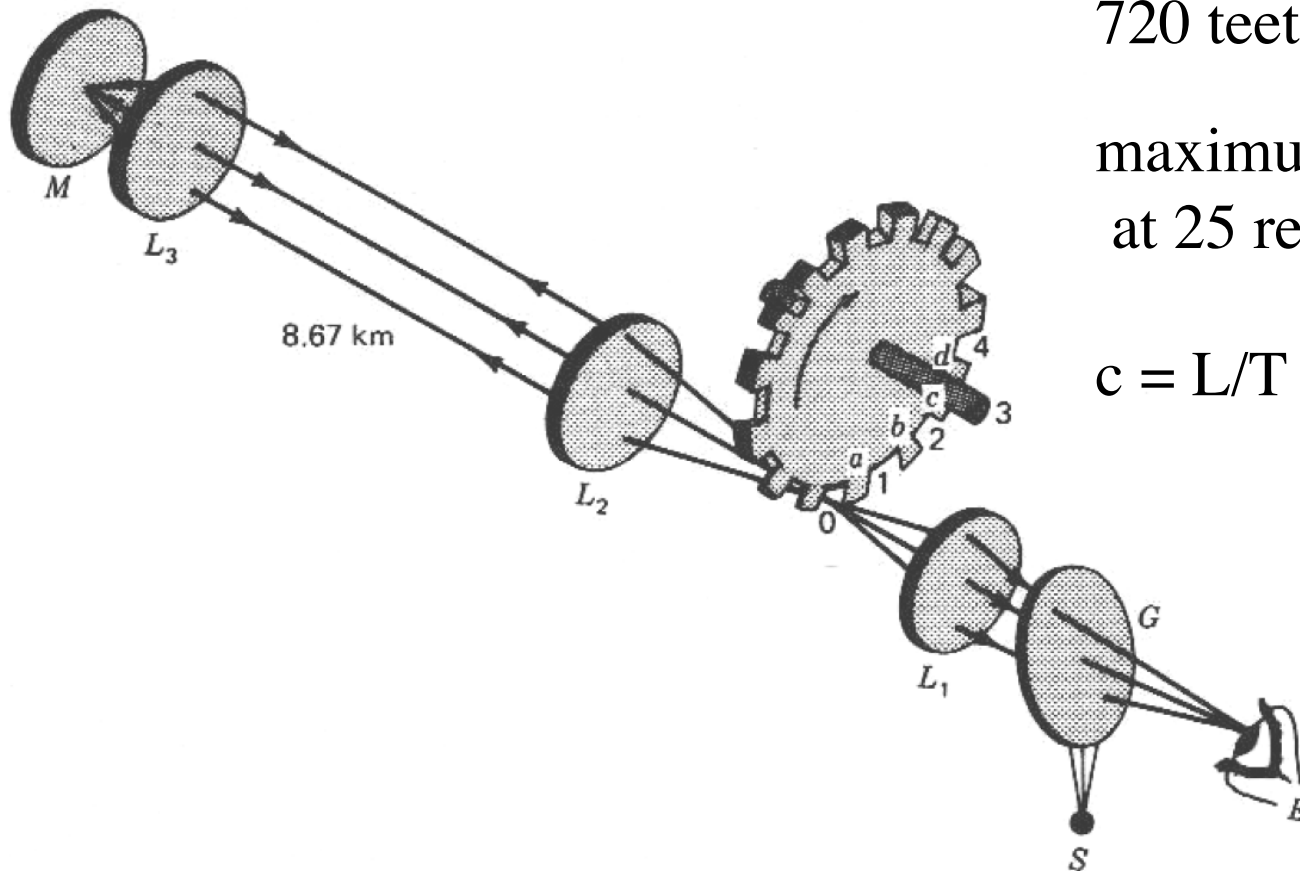

720 teeth in wheel

maximum transmission
at 25 revolutions/sec

$$c = L/T = 320,000 \text{ km/s}$$

Determination of the Velocity of Light

Need to Correct for Index of Air

Michelson (1926); Improved time of flight method.

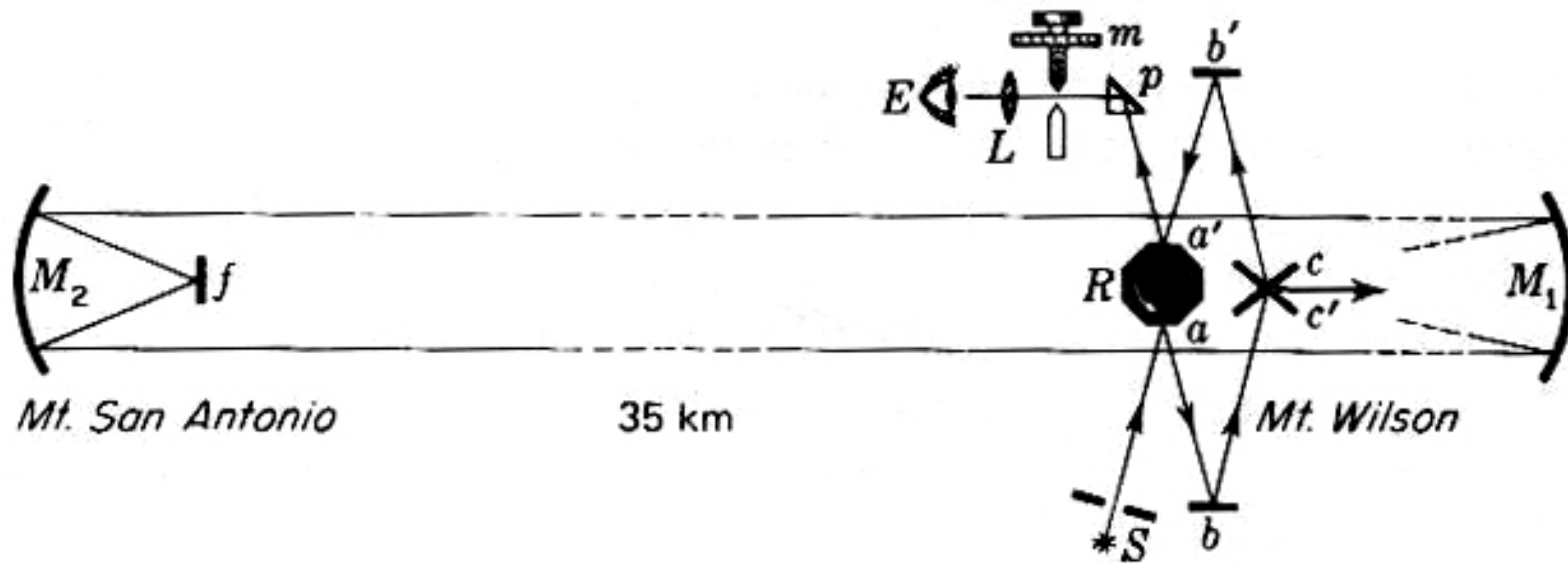

Rotating octagonal mirror

$$c = 299,296 \text{ km/s (or } 299,298 \text{ km/s)}$$

Some Approaches to Slow Light Propagation

- Use the linear response of atomic systems
or (better)
use quantum coherence (e.g., electromagnetically induced transparency) to modify and control this response
- Use of artificial materials (to modify the optical properties at the macroscopic level)

E.g., photonic crystals where strong spectral variation of the refractive index occurs near the edge of the photonic bandgap

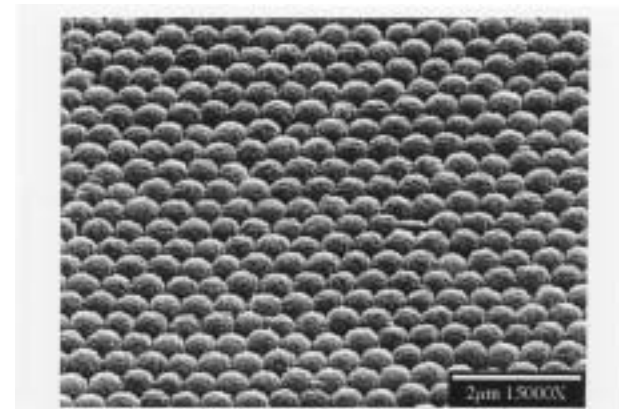

polystyrene photonic crystal

Slow Light and (Linear) Atomic Response

Want large dispersion.

Make use of sharp spectral lines of atomic vapors.

$$v_g = \frac{c}{n_g} \quad n_g = n + \omega \frac{dn}{d\omega}$$

Light Propagation in Atomic Vapors

$$n = \sqrt{\epsilon} = \sqrt{1 + 4\pi\chi} \quad \chi = \frac{Ne^2 / 2m\omega_0}{(\omega_0 - \omega) - i\gamma}$$

For N not too large, $n = n' + i n'' \approx 1 + 2\pi\chi$

$$n' \approx 1 + \frac{\pi Ne^2}{m\omega_0} \frac{\omega_0 - \omega}{(\omega_0 - \omega)^2 + \gamma^2}$$

$$n'' = \frac{\pi Ne^2}{2m\omega_0\gamma} \frac{\gamma^2}{(\omega_0 - \omega)^2 + \gamma^2}$$

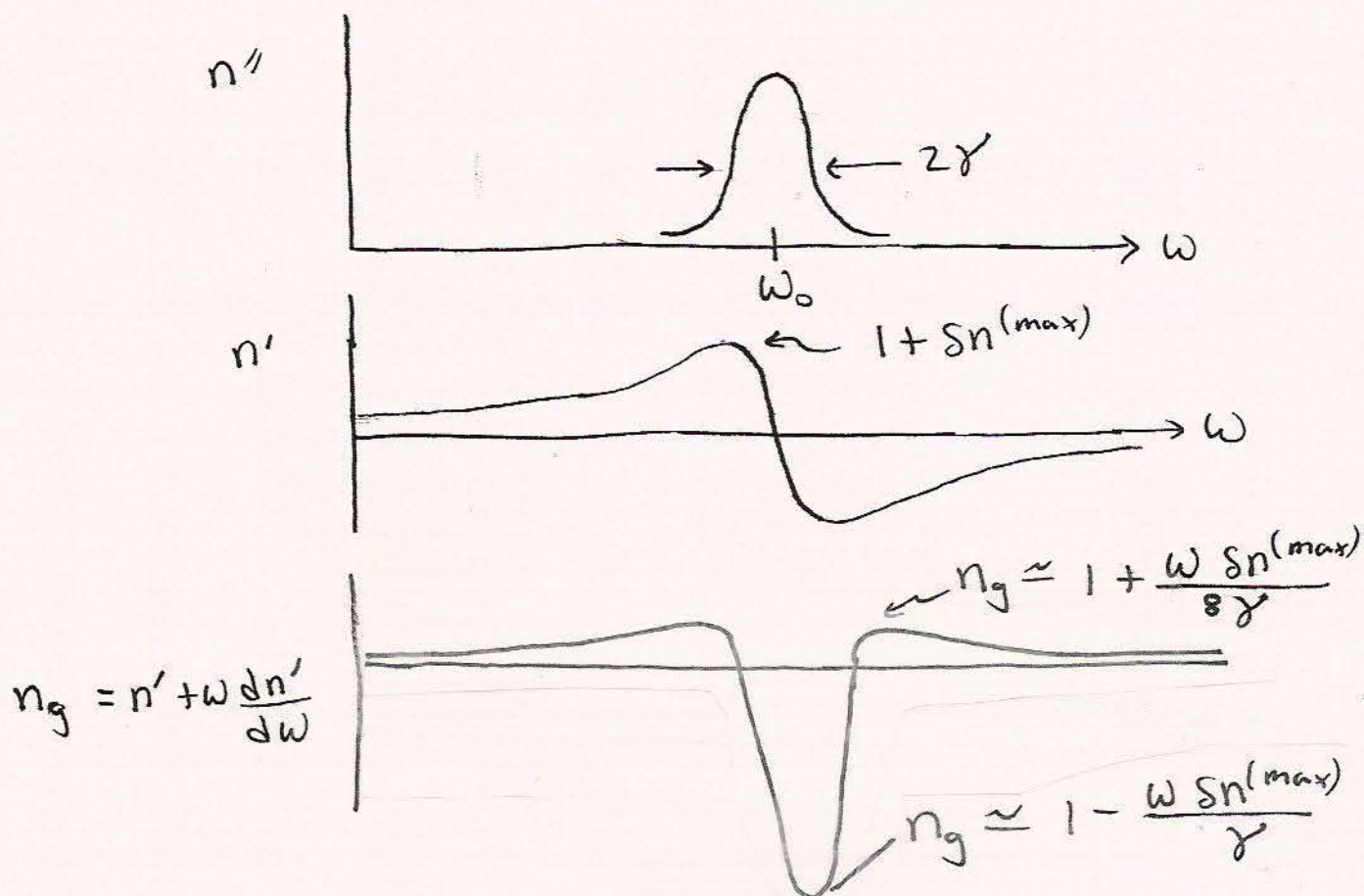

$$\frac{\omega \delta n^{(max)}}{\gamma} \approx \frac{2\pi(5 \times 10^{14})(0.1)}{2\pi(1 \times 10^9)} = 5 \times 10^4 \sim (!)$$

n_g can range from $+5 \times 10^4$ to -5×10^4 .

(But with lots of absorption)

Light Propagation in Atomic Vapors

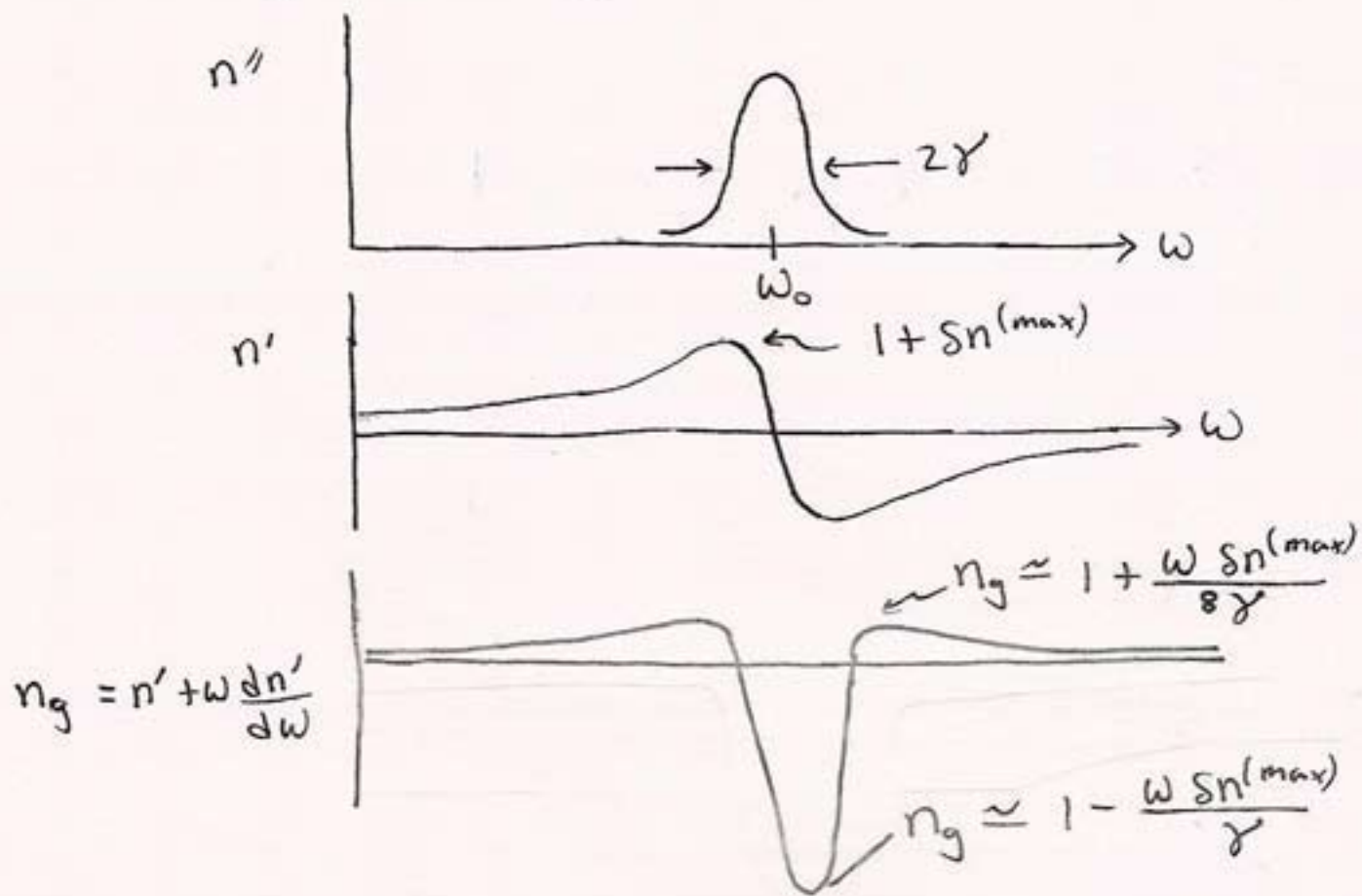

n_g can range from $+5 \times 10^4$ to -5×10^4 .

(But with lots of absorption)

Linear Pulse Propagation in an Absorbing Medium

S. Chu and S. Wong

Bell Laboratories, Murray Hill, New Jersey 07974

(Received 30 November 1981)

The pulse velocity in the linear regime in samples of GaP:N with a laser tuned to the bound A-exciton line is measured with use of a picosecond time-of-flight technique. The pulse is seen to propagate through the material with little pulse-shape distortion, and with an envelope velocity given by the group velocity even when the group velocity exceeds 3×10^{10} cm/sec, equals $\pm \infty$, or becomes negative. The results verify the predictions of Garrett and McCumber.

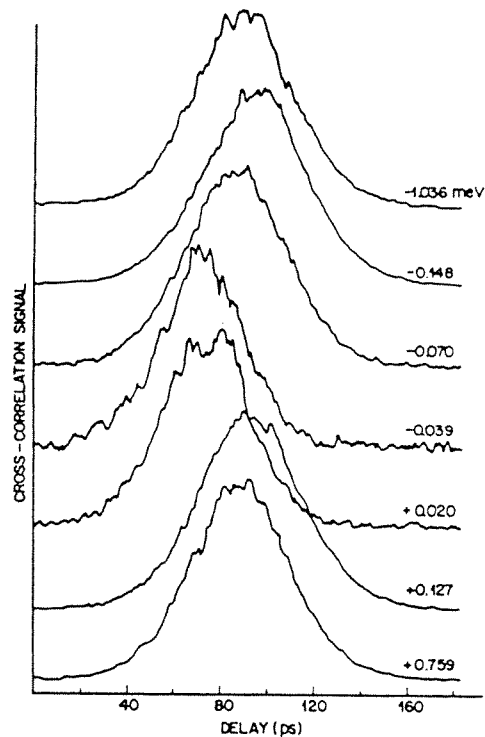
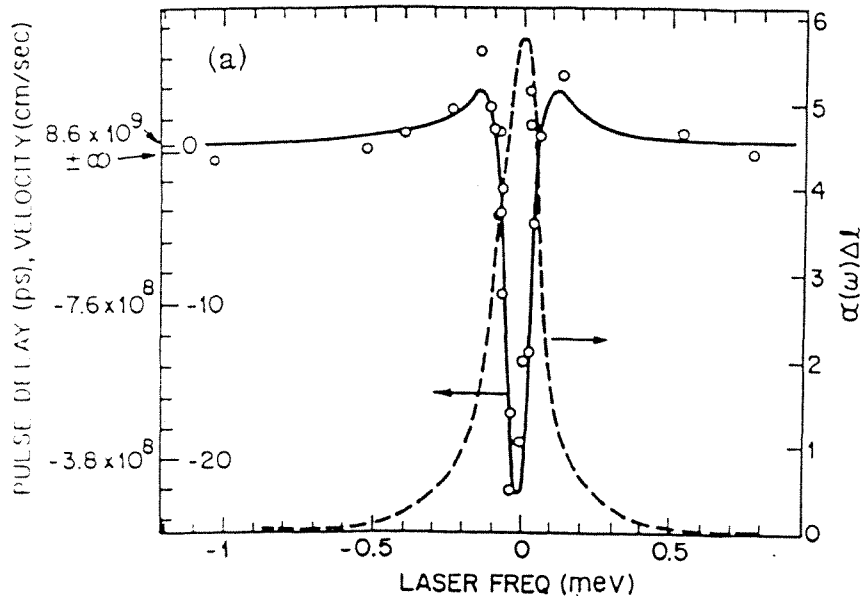

Nonlinear Optics and Slow Light

Nonlinear optics provides several opportunities for slow light

- Minimize absorption (through use of EIT)
- Larger value of the group index
(Many NLO interactions produce sub-Doppler linewidths)
- Presence of pump field allows control of group velocity

Slow Light in Atomic Vapors and BECs

Slow light propagation in atomic systems, facilitated by quantum coherence effects, has been successfully observed by

Hau and Harris

Welch and Scully

Budker

Ketterle

and many others

Light speed reduction to 17 metres per second in an ultracold atomic gas

Lene Vestergaard Hau^{*†}, S. E. Harris[‡], Zachary Dutton^{*†}
& Cyrus H. Behroozi^{*§}

^{*} Rowland Institute for Science, 100 Edwin H. Land Boulevard, Cambridge,
Massachusetts 02142, USA

[†] Department of Physics, [§] Division of Engineering and Applied Sciences,
Harvard University, Cambridge, Massachusetts 02138, USA

[‡] Edward L. Ginzton Laboratory, Stanford University, Stanford, California 94305,
USA

Nature, 397, 594, (1999).

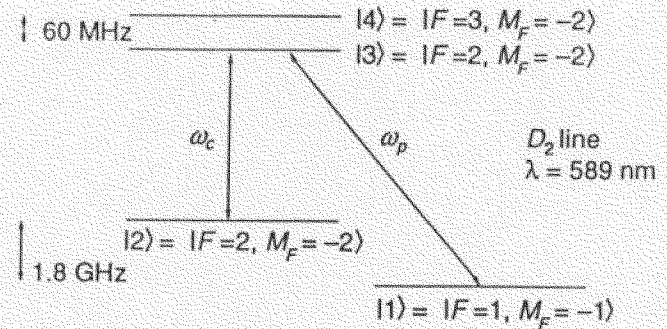

$$v_g = \frac{c}{n(\omega_p) + \omega_p \frac{dn}{d\omega_p}} \approx \frac{\hbar c \epsilon_0 |\Omega_c|^2}{2\omega_p |\mu_{13}|^2 N}$$

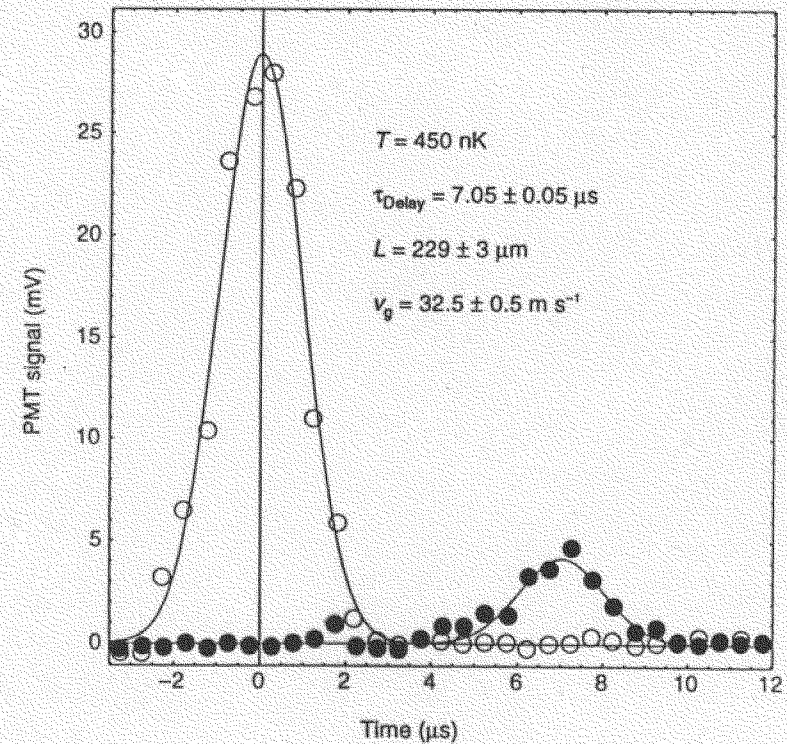
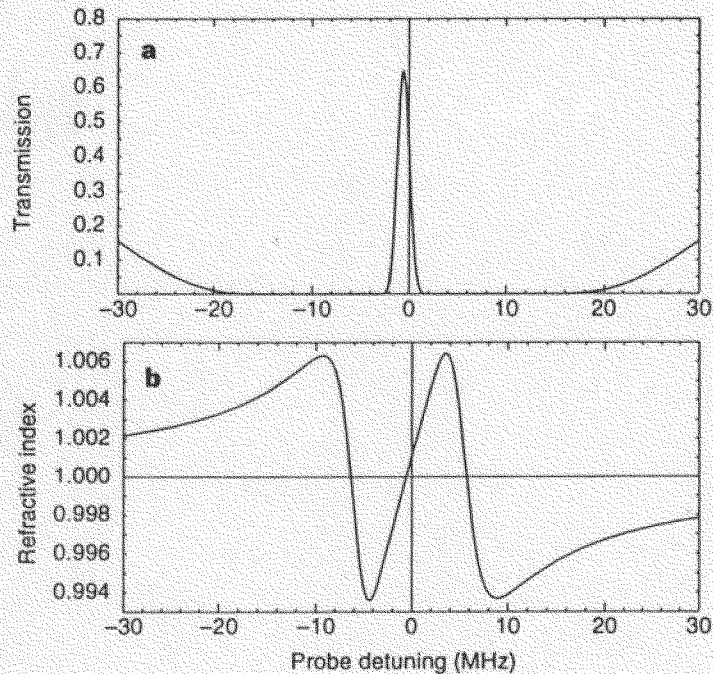

Challenge / Goal (2003)

Slow light is a room-temperature, solid-state material.

Our solution:

Slow light *via* coherent population oscillations (CPO), a quantum coherence effect related to EIT but which is less sensitive to dephasing processes.

Slow Light in Ruby

Recall that $n_g = n + \omega(dn/d\omega)$. Need a large $dn/d\omega$. (How?)

Kramers-Kronig relations:

Want a very narrow feature in absorption line.

Well-known “trick” for doing so:

Make use of spectral holes due to population oscillations.

Hole-burning in a homogeneously broadened line; requires $T_2 \ll T_1$.

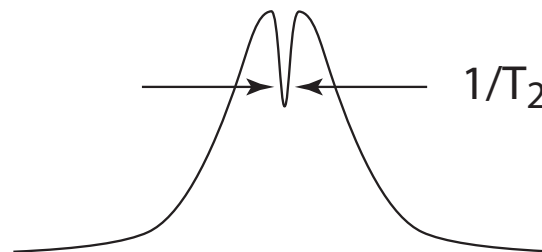

inhomogeneously
broadened medium

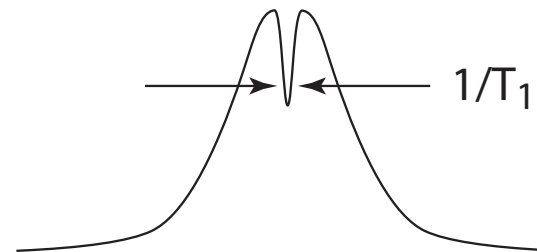

homogeneously
broadened medium
(or inhomogeneously
broadened)

Slow Light Experimental Setup

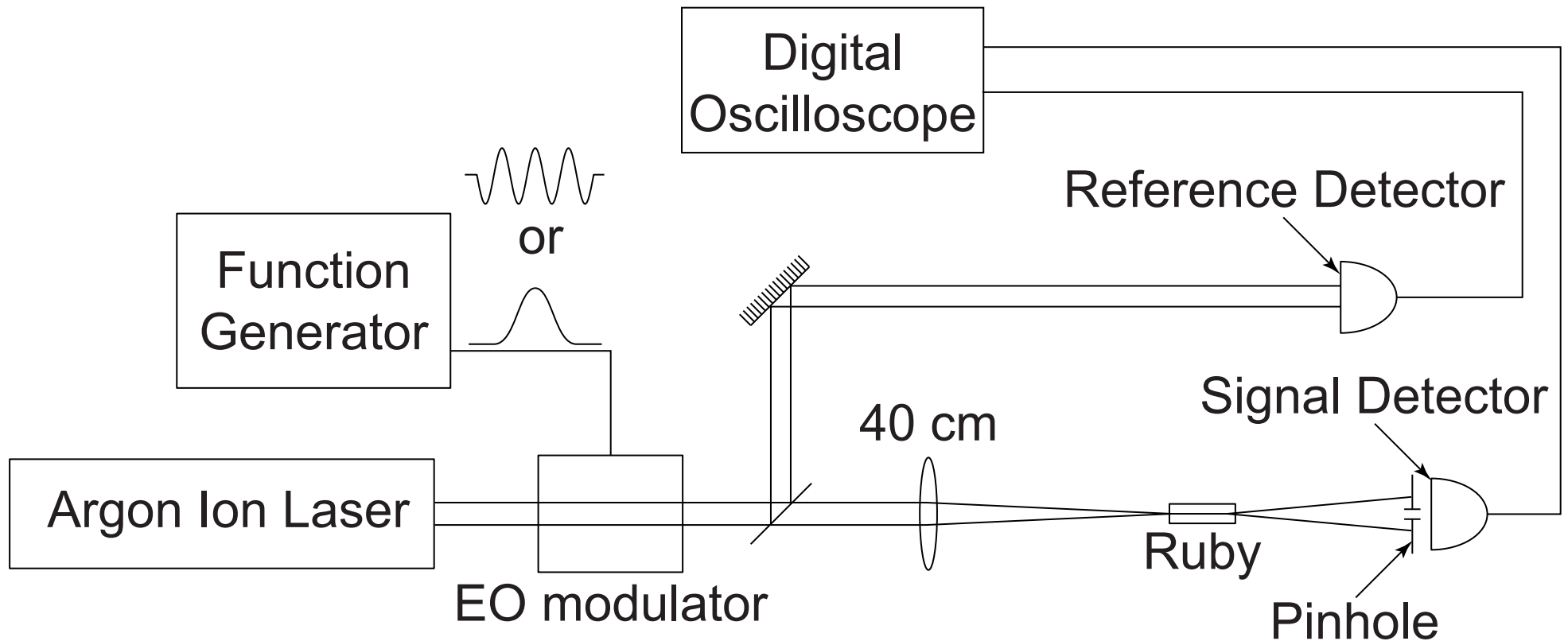

7.25-cm-long ruby laser rod (pink ruby)

Measurement of Delay Time for Harmonic Modulation

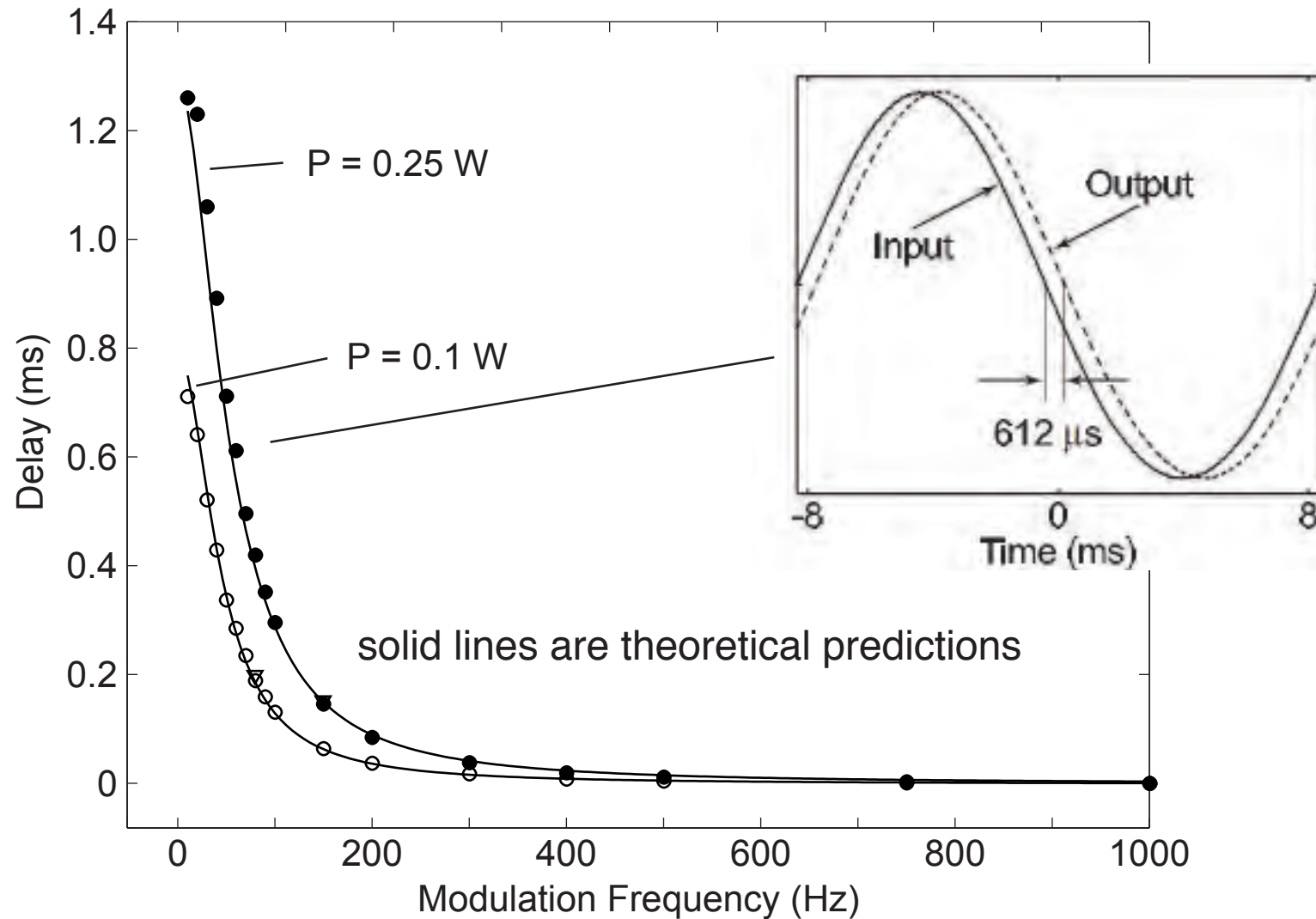

For 1.2 ms delay, $v = 60 \text{ m/s}$ and $n_g = 5 \times 10^6$

Gaussian Pulse Propagation Through Ruby

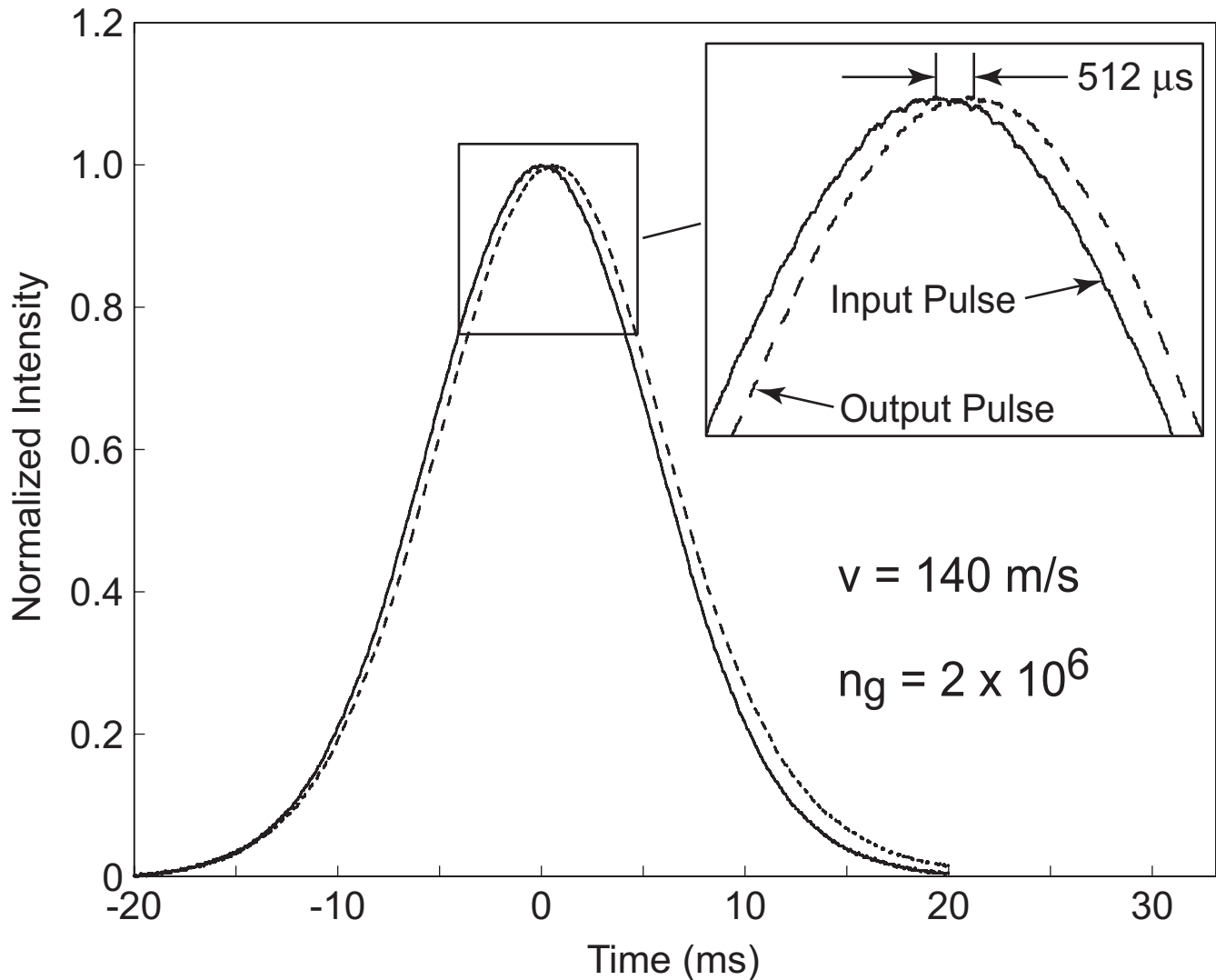

No pulse distortion!

Matt Bigelow and Nick Lepeshkin in the Lab

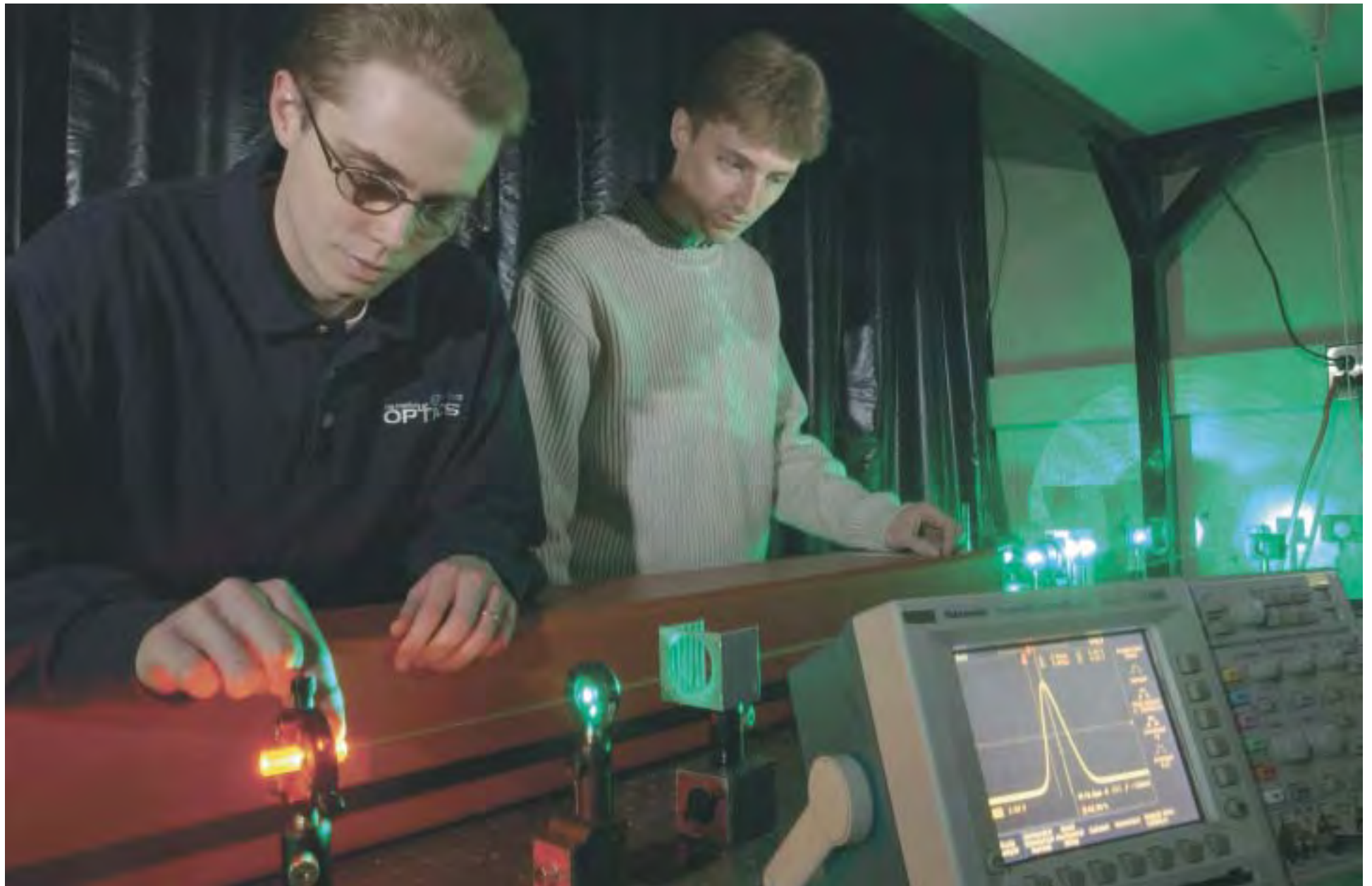

Advantages of Coherent Population Oscillations for Slow Light

Works in solids

Works at room temperature

Insensitive of dephasing processes

Laser need not be frequency stabilized

Works with single beam (self-delayed)

Delay can be controlled through input intensity

Alexandrite Displays both Saturable and Reverse-Saturable Absorption

- Both slow and fast propagation observed in alexandrite

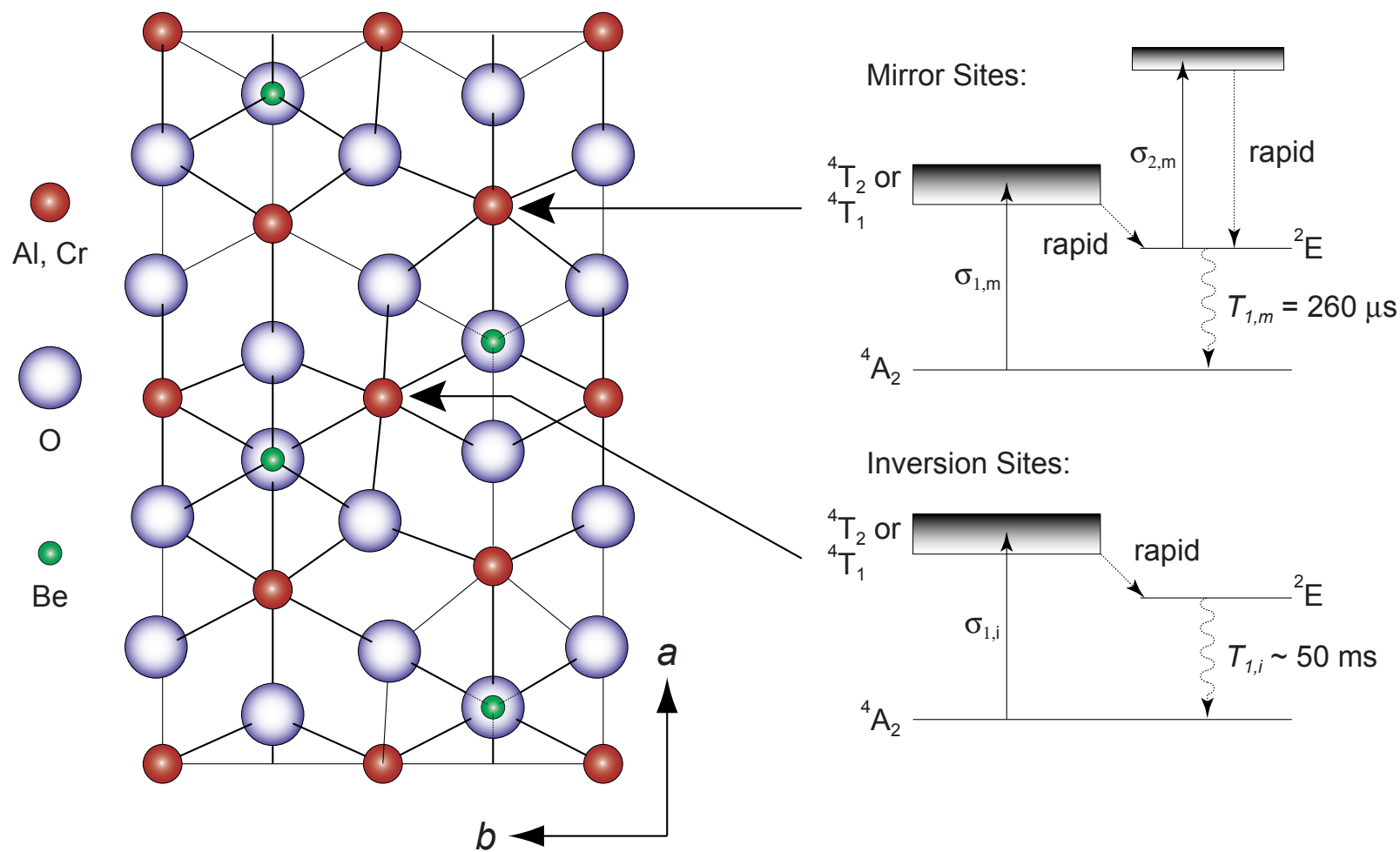

Inverse-Saturable Absorption Produces Superluminal Propagation in Alexandrite

At 476 nm, alexandrite is an inverse saturable absorber

Negative time delay of 50 μs corresponds to a velocity of -800 m/s

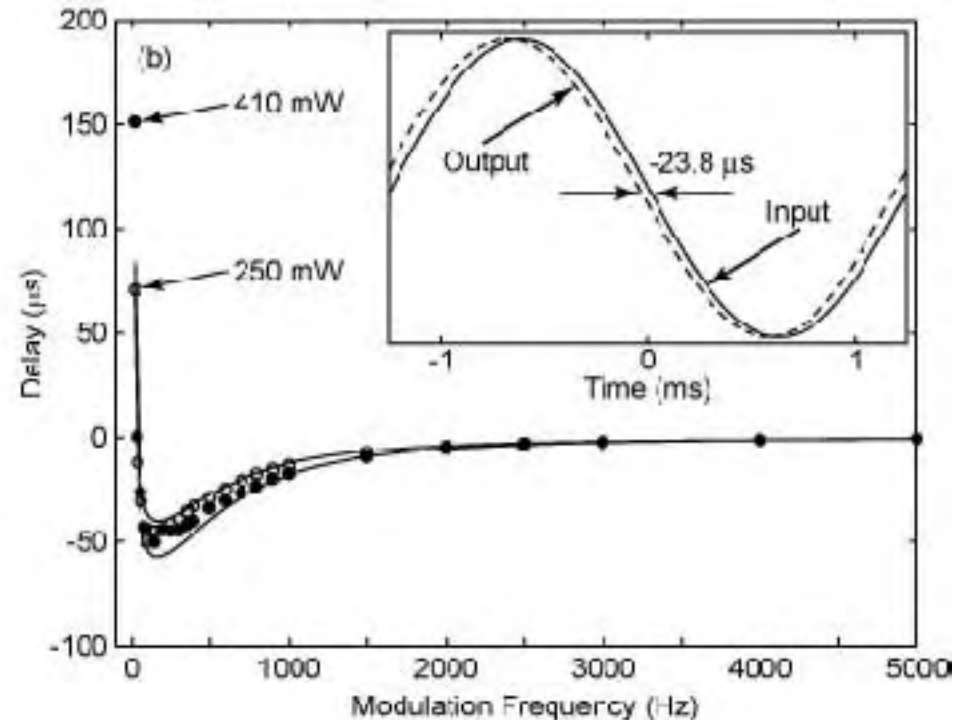
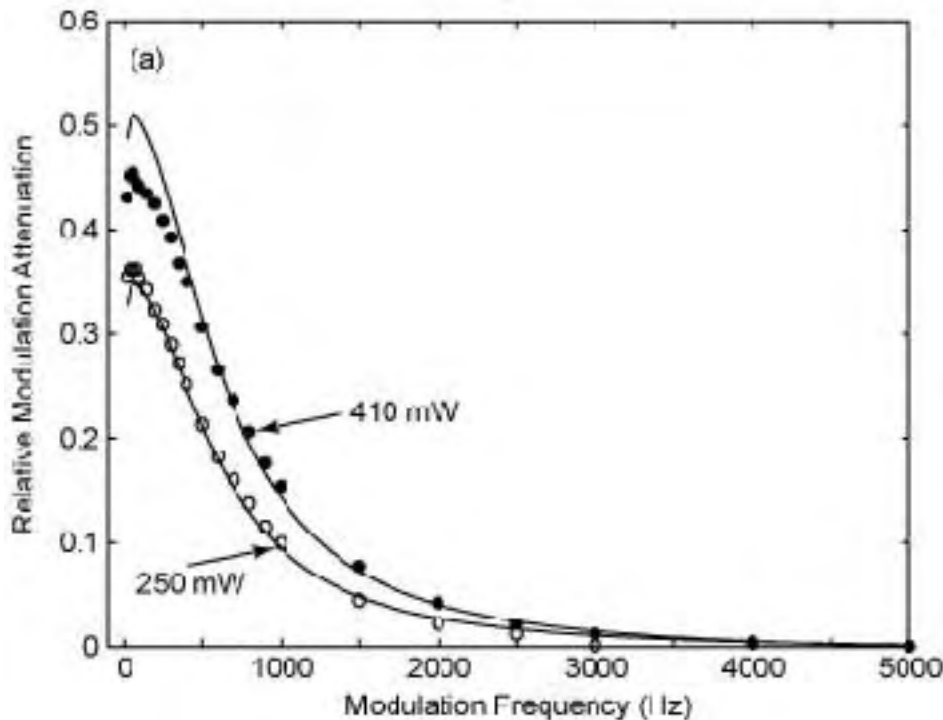

M. Bigelow, N. Lepeshkin, and RWB, Science, 2003

Numerical Modeling of Pulse Propagation Through Slow and Fast-Light Media

Numerically integrate the paraxial wave equation

$$\frac{\partial A}{\partial z} - \frac{1}{v_g} \frac{\partial A}{\partial t} = 0$$

and plot $A(z,t)$ versus distance z .

Assume an input pulse with a Gaussian temporal profile.

Study three cases:

Slow light $v_g = 0.5 c$

Fast light $v_g = 5 c$ and $v_g = -2 c$

Pulse Propagation through a Slow-Light Medium ($n_g = 2$, $v_g = 0.5 c$)

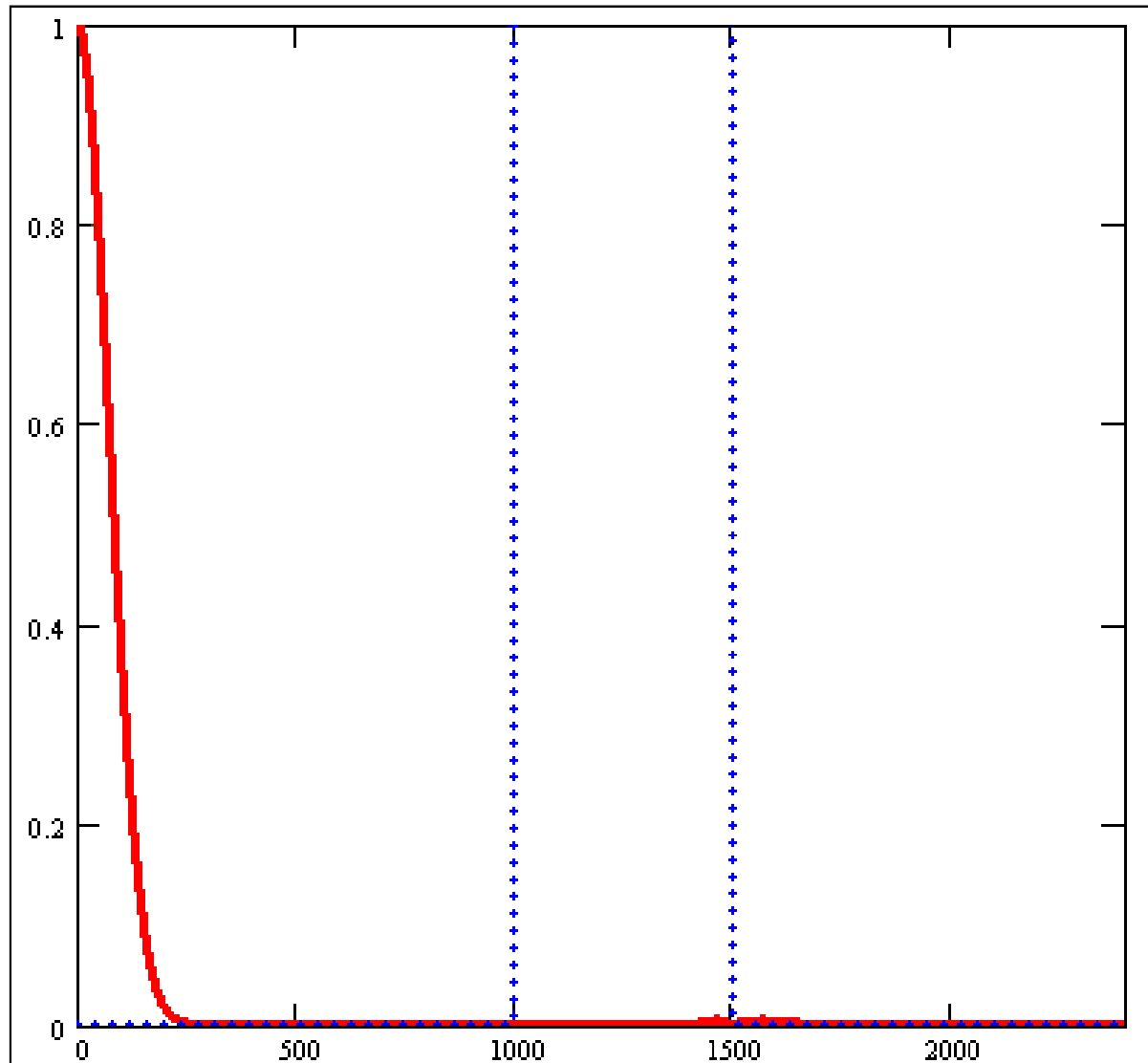

Pulse Propagation through a Fast-Light Medium ($n_g = .2$, $v_g = 5 c$)

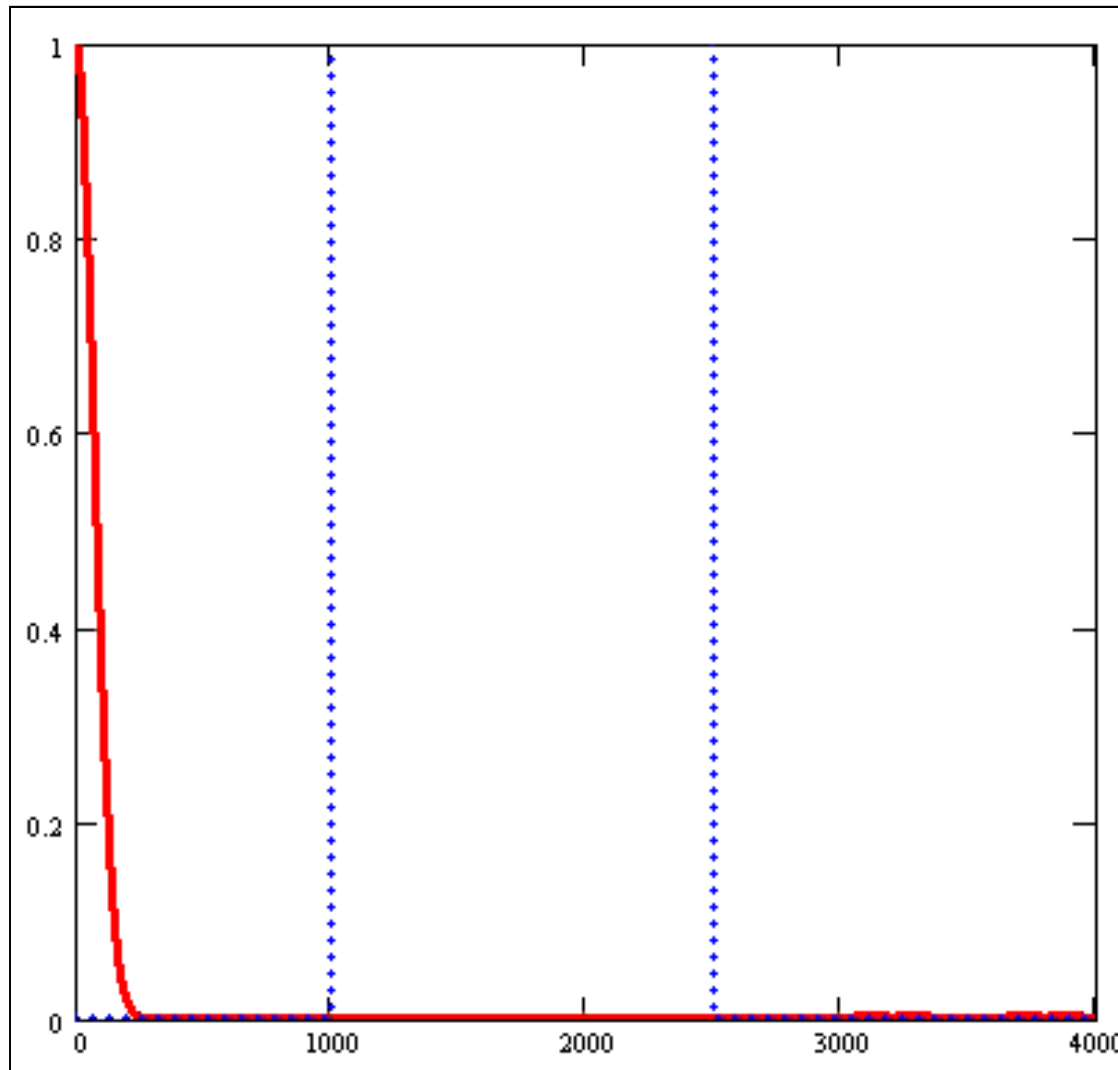

Pulse Propagation through a Fast-Light Medium ($n_g = -.5$, $v_g = -2 c$)

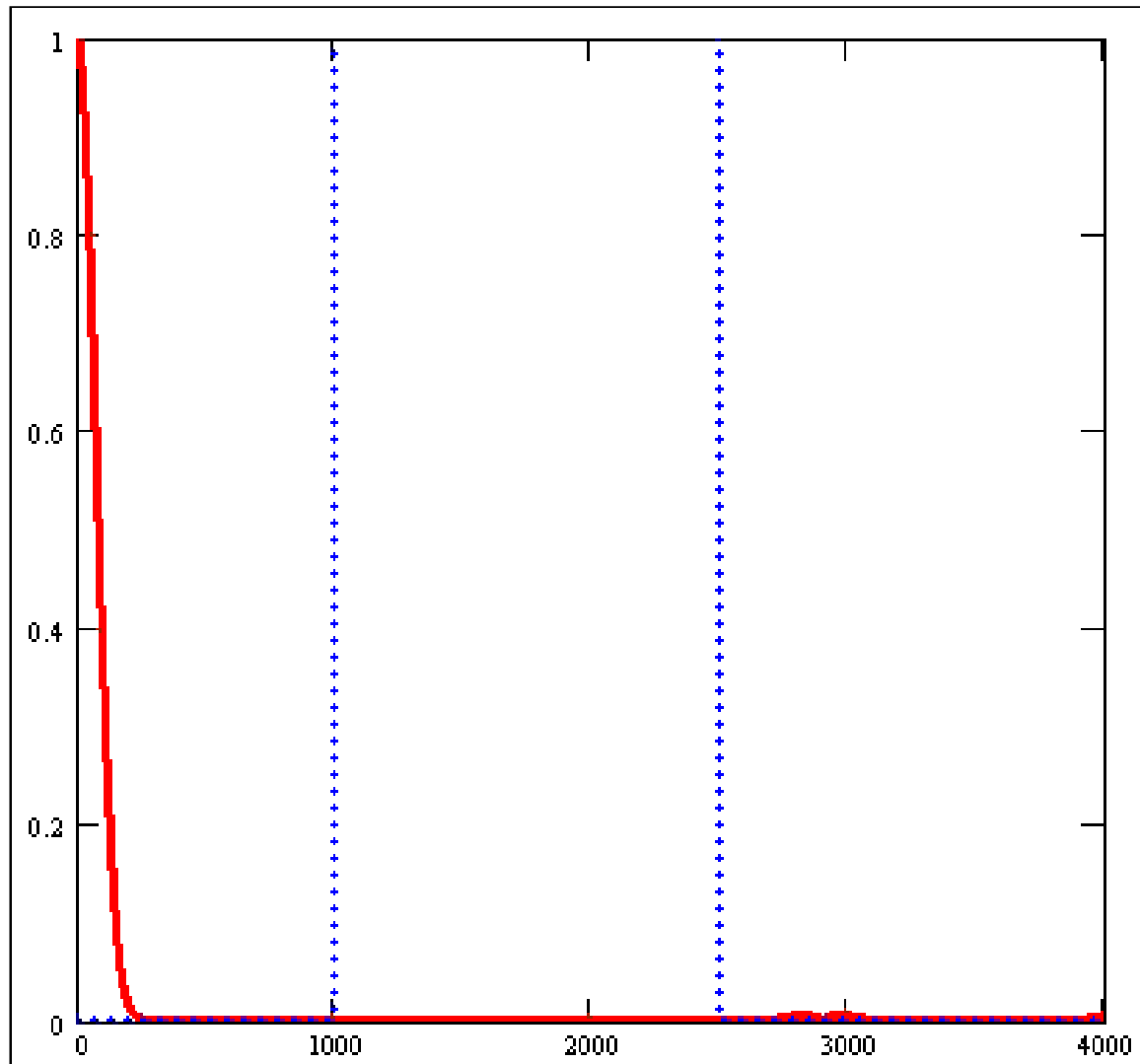

Slow and Fast Light in an Erbium Doped Fiber Amplifier

- Fiber geometry allows long propagation length
- Saturable gain or loss possible depending on pump intensity

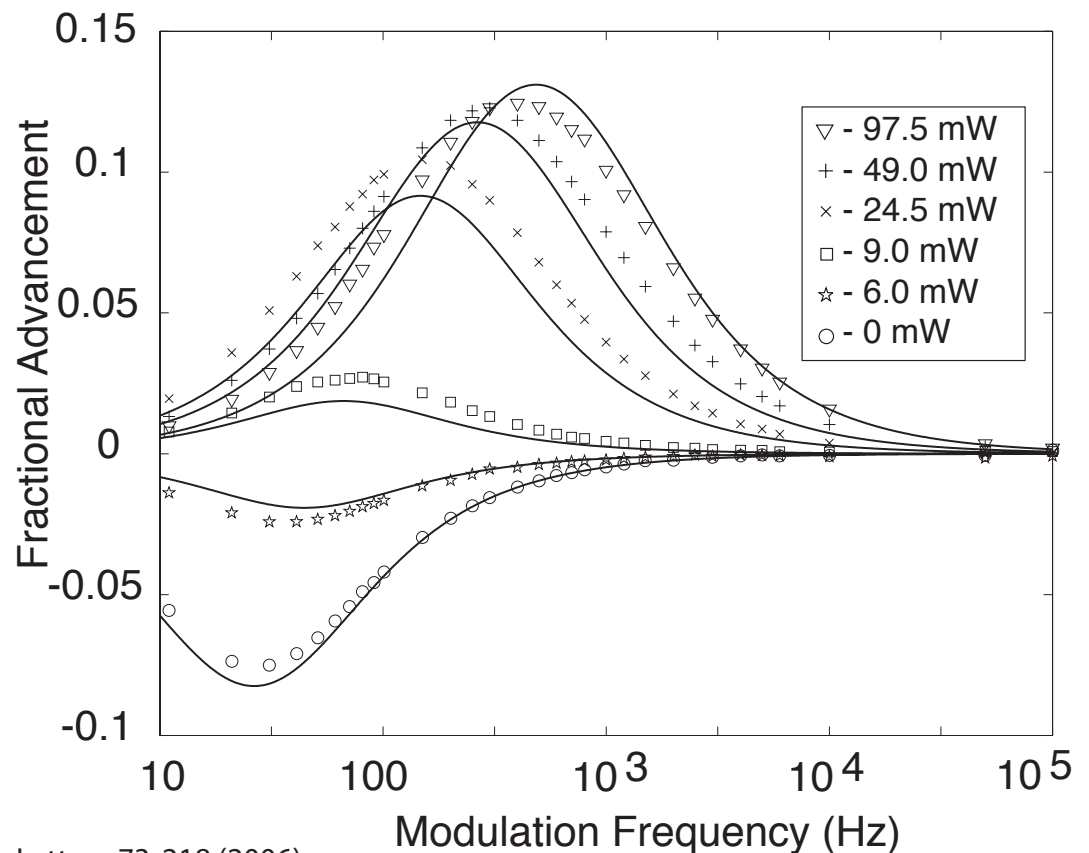
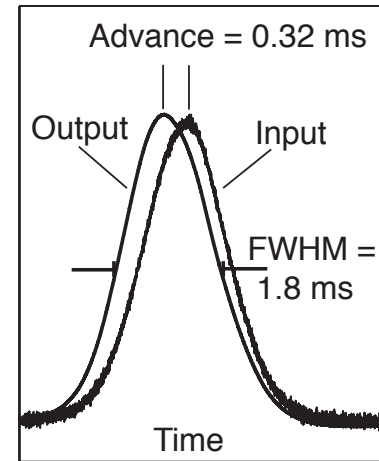
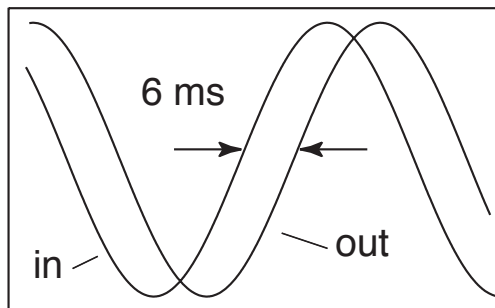
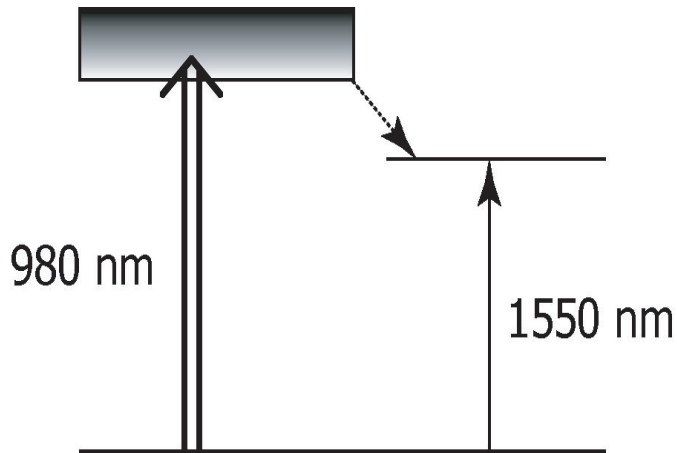

Observation of Backward Pulse Propagation in an Erbium-Doped-Fiber Optical Amplifier

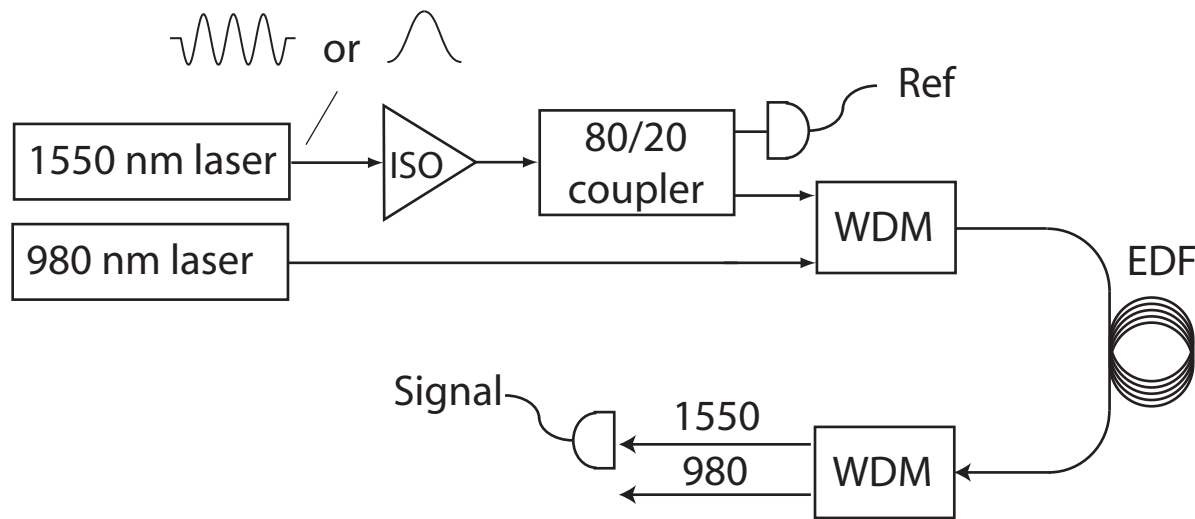

We time-resolve the propagation of the pulse as a function of position along the erbium-doped fiber.

Procedure

- cutback method
- couplers embedded in fiber

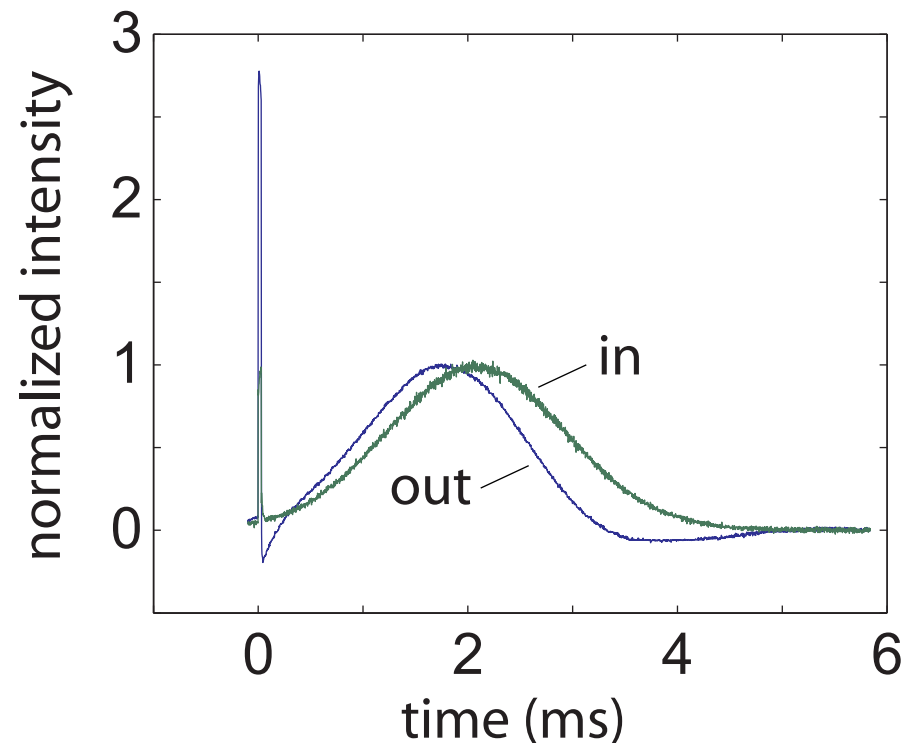

Experimental Results: Backward Propagation in Erbium-Doped Fiber

Normalized: (Amplification removed numerically)

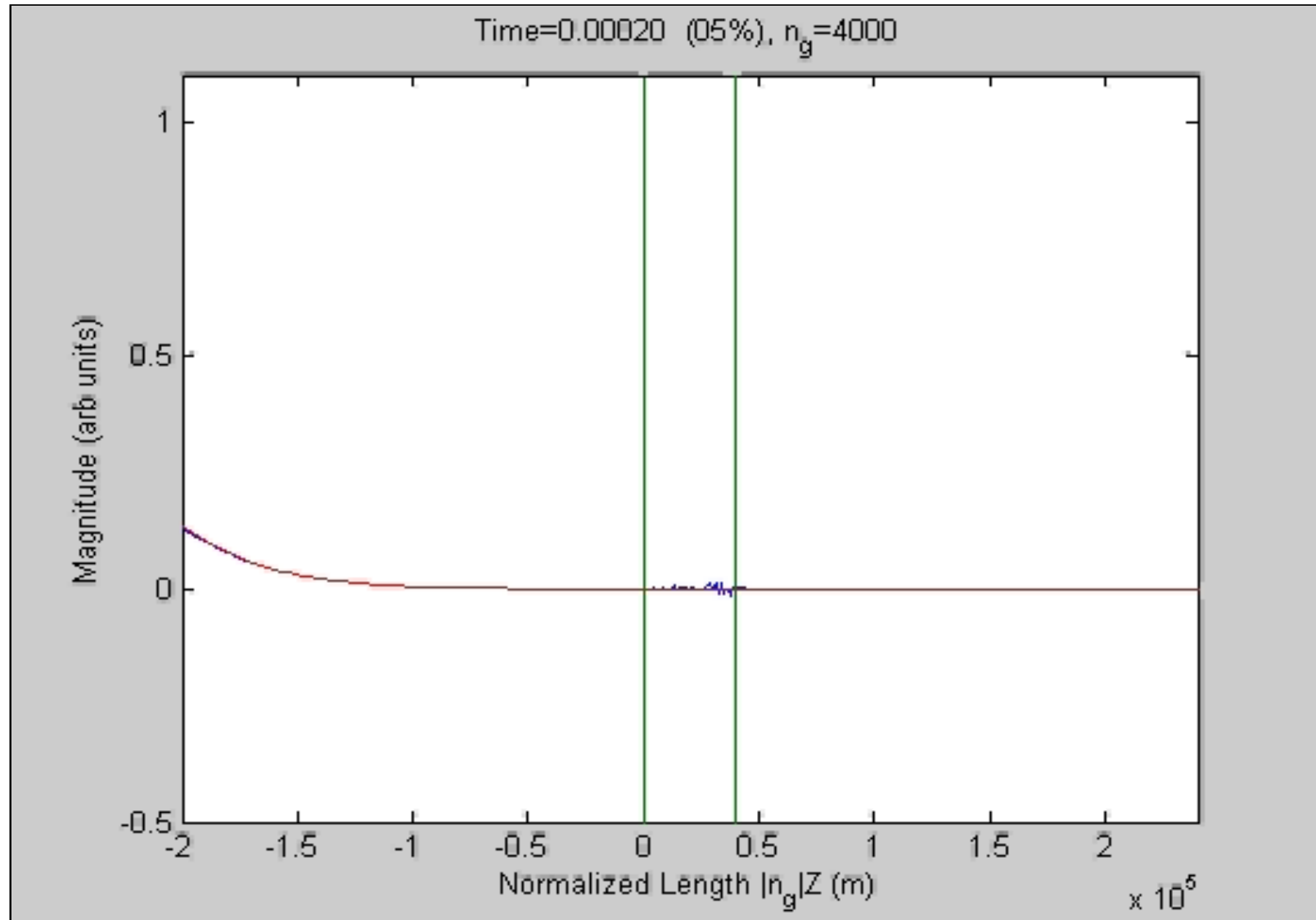

Experimental Results: Backward Propagation in Erbium-Doped Fiber

Un-Normalized

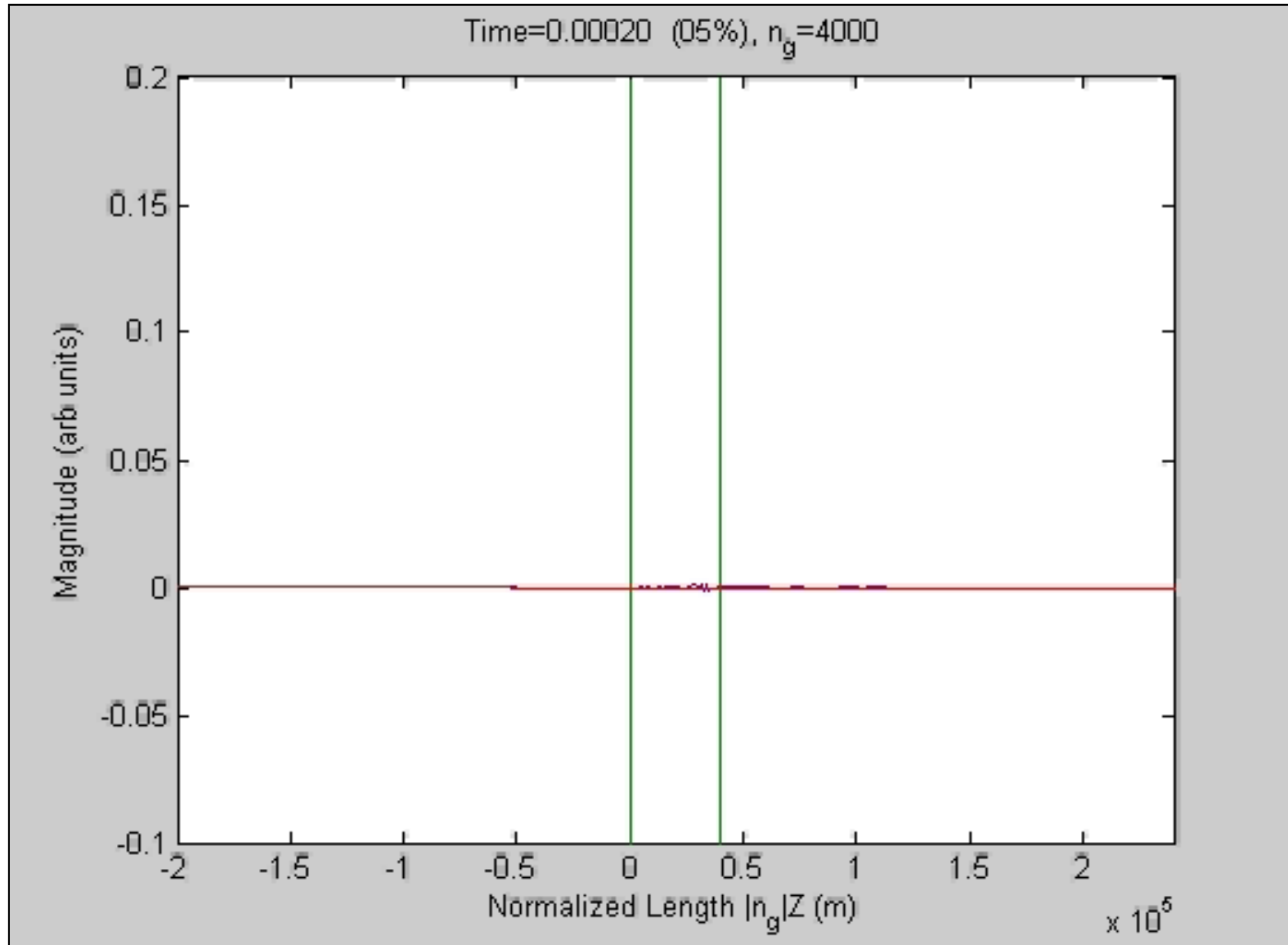

Observation of Backward Pulse Propagation in an Erbium-Doped-Fiber Optical Amplifier

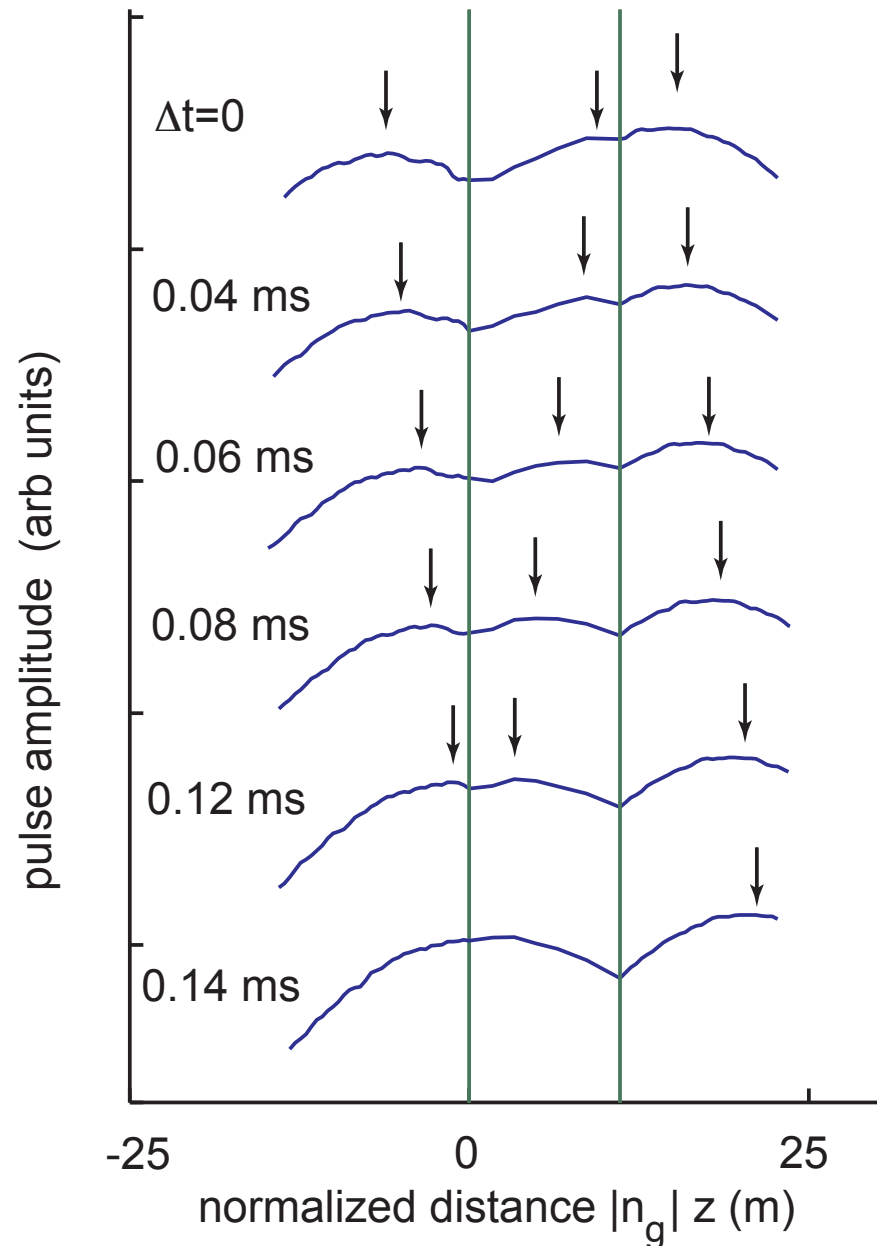

Observation of Backward Pulse Propagation in an Erbium-Doped-Fiber Optical Amplifier

Summary:

“Backwards” propagation is a realizable physical effect.

(Of course, many other workers have measured negative time delays. Our contribution was to measure the pulse evolution within the material medium.)

Causality and Superluminal Signal Transmission

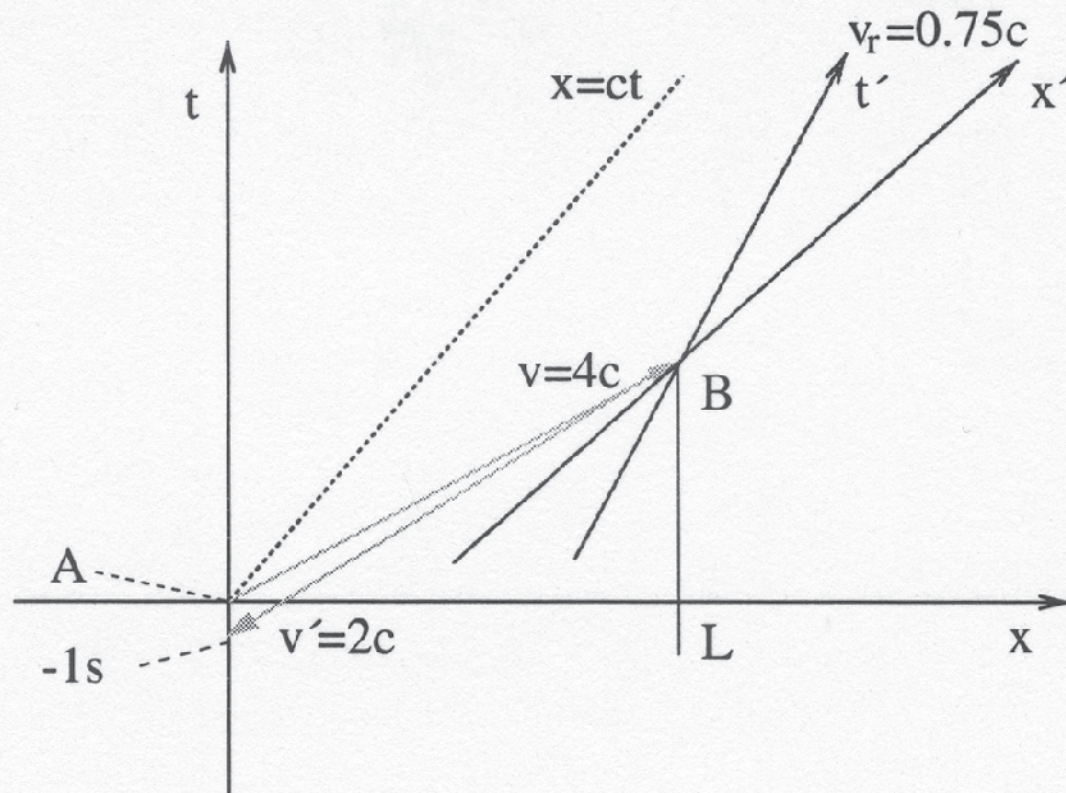
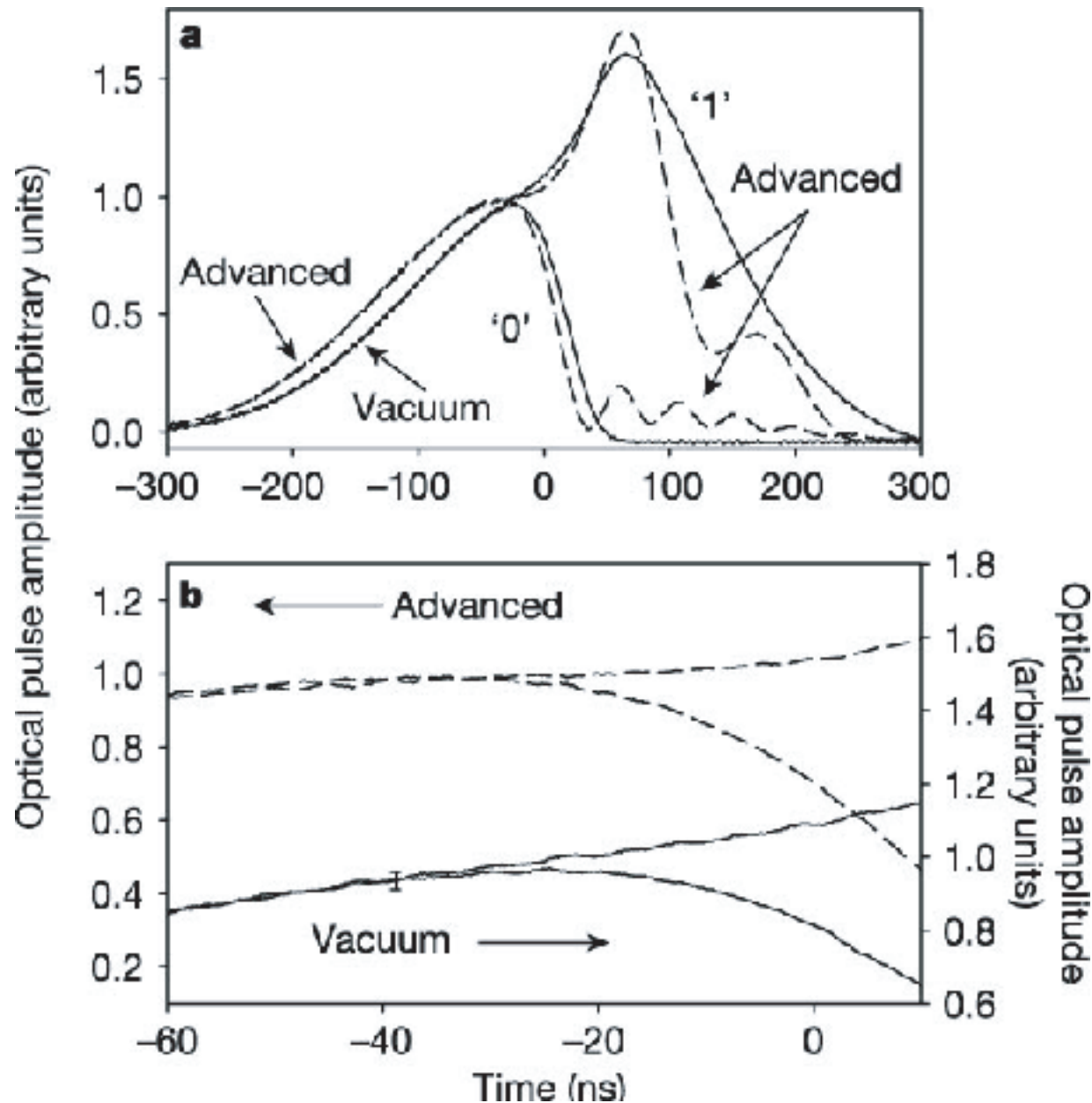

Fig. 6 Coordinates of two inertial observers **A** $(0, 0)$ and **B** with $O(x, t)$ and $O'(x', t')$ moving with a relative velocity of $0.75c$. The distance L between **A** and **B** is 2000000 km. **A** makes use of a signal velocity $v_s = 4c$ and **B** makes use of $v'_s = 2c$. The numbers in the example are chosen arbitrarily. The signal returns -1 s in the past in **A**.

Information Velocity in a Fast Light Medium



M.D. Stenner, D.J. Gauthier, and M.I. Neifeld, *Nature*, 425 695 (2003).

Pulses are not distinguishable "early."

$$v_i \leq c$$

Propagation of a Truncated Pulse through Alexandrite as a Fast-Light Medium

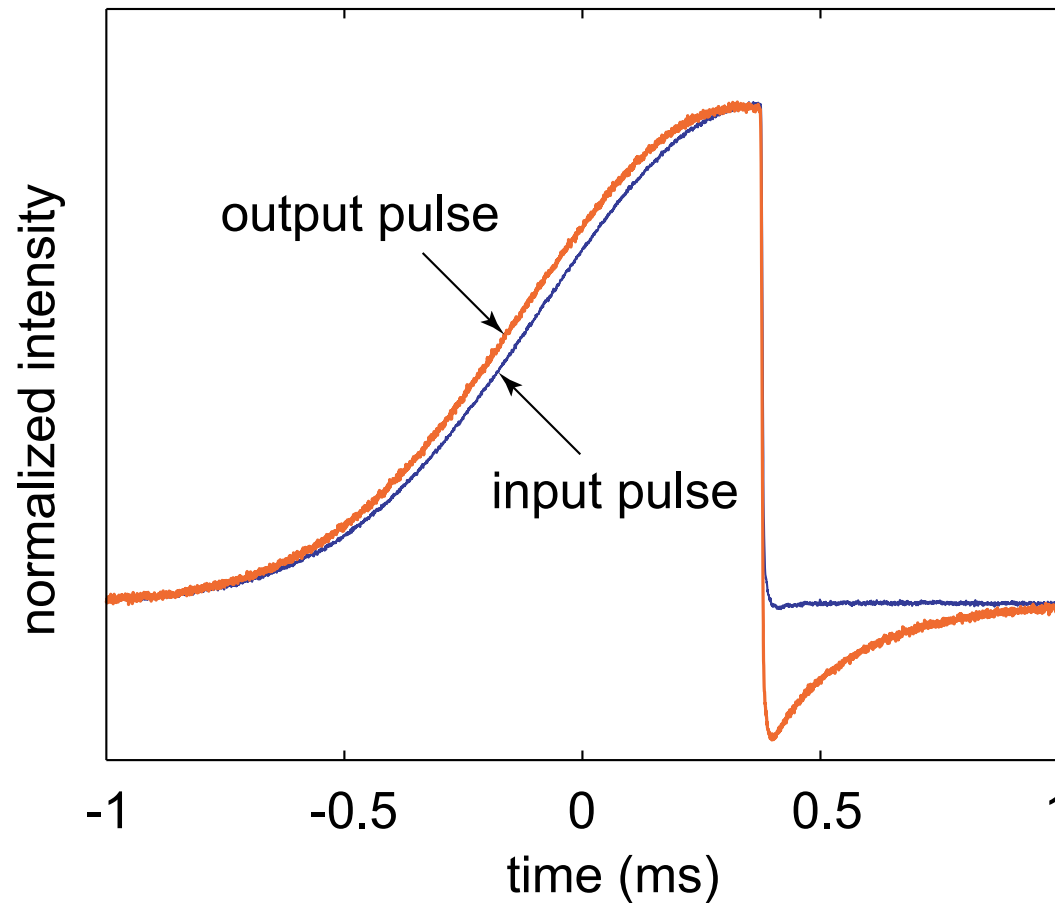

Smooth part of pulse propagates at group velocity

Discontinuity propagates at phase velocity

How to Reconcile Superluminality with Causality

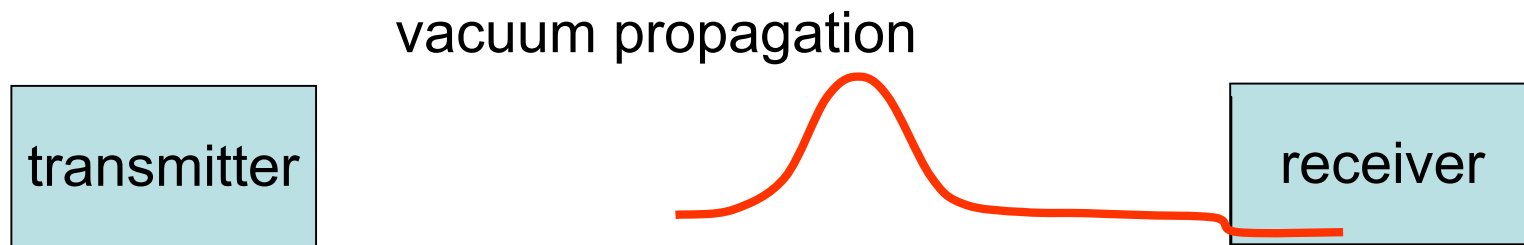

Information Velocity – Tentative Conclusions

In principle, the information velocity is equal to c for both slow- and fast-light situations. **So why is slow and fast light even useful?**

Because in many practical situations, we can perform reliable measurements of the information content only near the peak of the pulse.

In this sense, useful information often propagates at the group velocity.

In a real communication system it would be really stupid to transmit pulses containing so much energy that one can reliably detect the very early leading edge of the pulse.

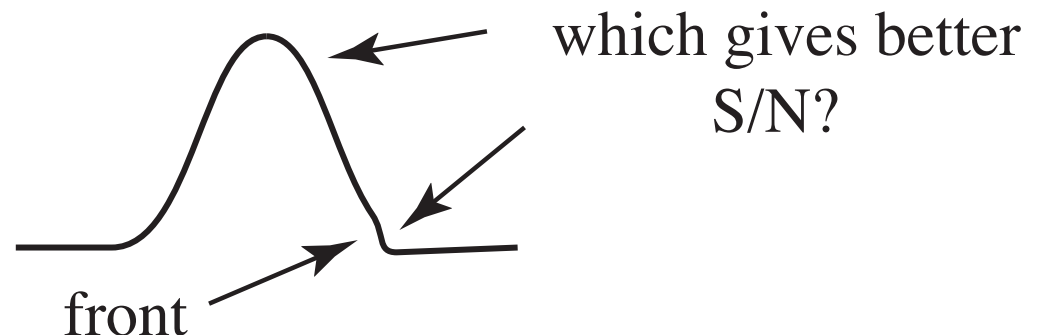



All-Optical Switch

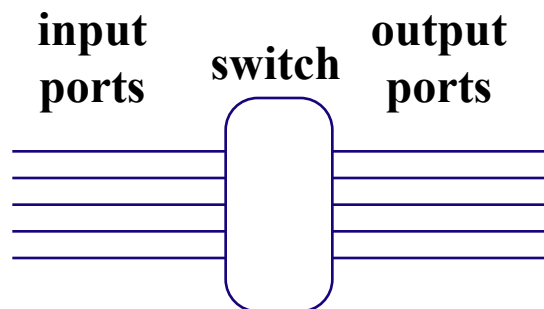

Use Optical Buffering to Resolve Data-Packet Contention

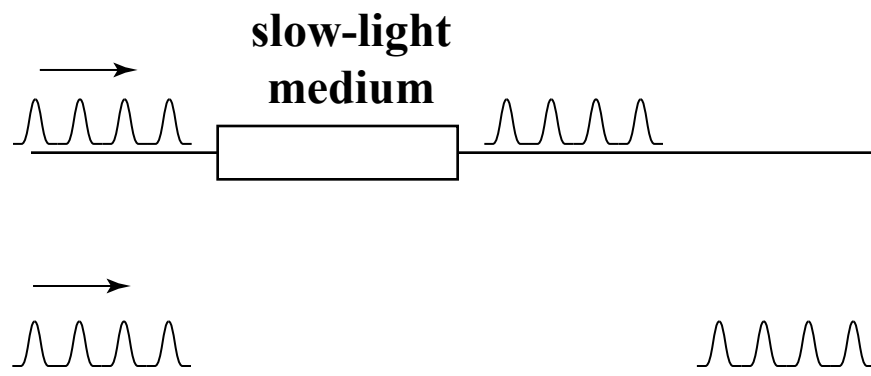

But what happens if two data packets arrive simultaneously?

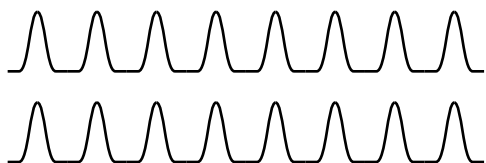

Controllable slow light for optical buffering can dramatically increase system performance.

Review of Slow-Light Fundamentals

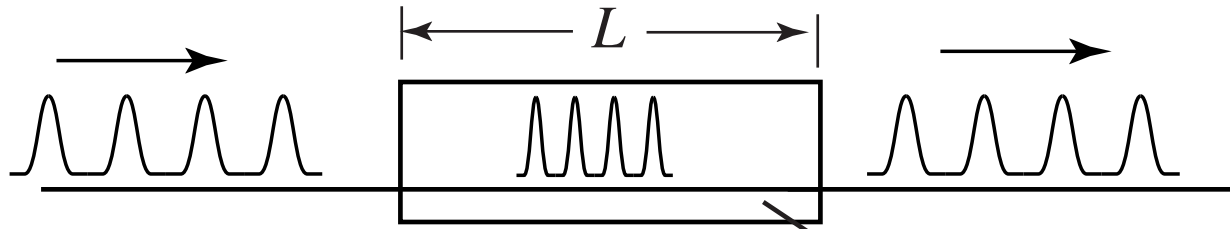

group velocity: $v_g = \frac{c}{n_g}$

group index: $n_g = n + \omega \frac{dn}{d\omega}$

group delay: $T_g = \frac{L}{v_g} = \frac{Ln_g}{c}$

controllable delay: $T_{\text{del}} = T_g - L/c = \frac{L}{c}(n_g - 1)$

To make controllable delay as large as possible:

- make L as large as possible (reduce residual absorption)
- maximize the group index

Systems Considerations: Maximum Slow-Light Time Delay

“Slow light”: group velocities $< 10^{-6} c$!

Proposed applications: controllable optical delay lines
optical buffers, true time delay for synthetic aperture radar.

Key figure of merit:

normalized time delay = total time delay / input pulse duration
 \approx information storage capacity of medium

Best result until very recently: 7 pulse lengths delay (Harris 1995)

But data packets used in telecommunications contain $\approx 10^3$ bits

What are the prospects for obtaining slow-light delay lines with 10^3 bits capacity?

Generic Model of EIT and CPO Slow-Light Systems

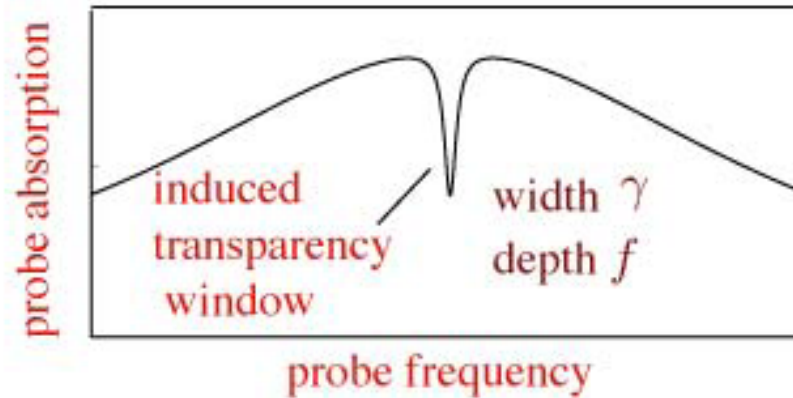

probe absorption

$$\alpha(\delta) = \alpha_0 \left(1 - \frac{f}{1 + \delta^2/\gamma^2} \right) \approx \alpha_0 \left[(1 - f) - f \frac{\delta^2}{\gamma^2} \right] \quad \text{where} \quad \delta = \omega - \omega_0$$

probe refractive index (by Kramers Kronig)

$$n(\delta) = n_0 + f \left(\frac{\alpha_0 \lambda}{4\pi} \right) \frac{\delta/\gamma}{1 + \delta^2/\gamma^2} \approx n_0 + f \left(\frac{\alpha_0 \lambda}{4\pi} \right) \frac{\delta}{\gamma} \left(1 - \frac{\delta^2}{\gamma^2} \right)$$

probe group index

$$n_g \approx f \left(\frac{\alpha_0 \lambda}{4\pi} \right) \frac{\omega}{\gamma} \left(1 - \frac{3\delta^2}{\gamma^2} \right).$$

induced delay

$$T_{\text{del}} \approx \frac{f \alpha_0 L}{2\gamma} \left(1 - \frac{3\delta^2}{\gamma^2} \right)$$

normalized induced delay ($T_0 =$ pulse width)

$$\frac{T_{\text{del}}}{T_0} \approx \frac{f \alpha_0 L}{2\gamma T_0} \left(1 - \frac{3\delta^2}{\gamma^2} \right)$$

Modeling of Slow-Light Systems

We conclude that there are no *fundamental* limitations to the maximum fractional pulse delay. Our model includes gvd and spectral reshaping of pulses.

However, there are serious *practical* limitations, primarily associated with residual absorption.

Boyd, Gauthier, Gaeta, and Willner, Phys. Rev. A 71, 023801, 2005.

Tunable Delays of up to 80 Pulse Widths in Atomic Cesium Vapor

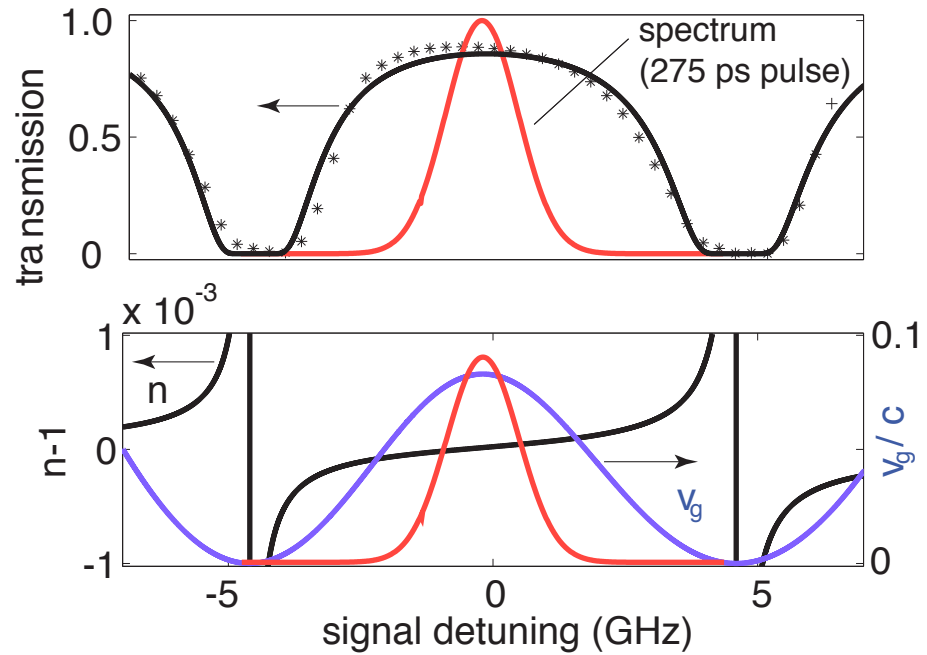
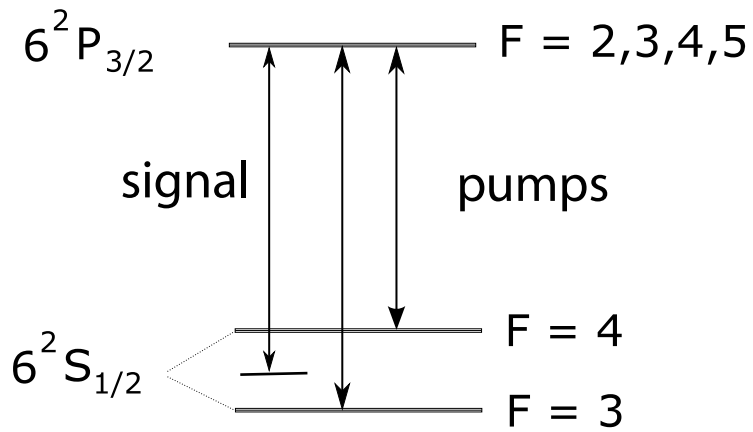

- coarse tuning: temperature

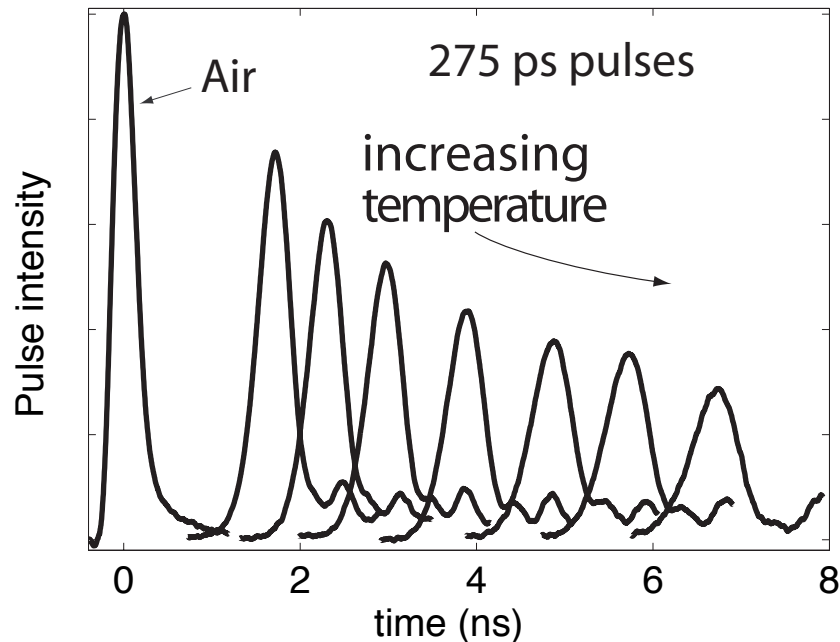

- fine tuning: optical pumping

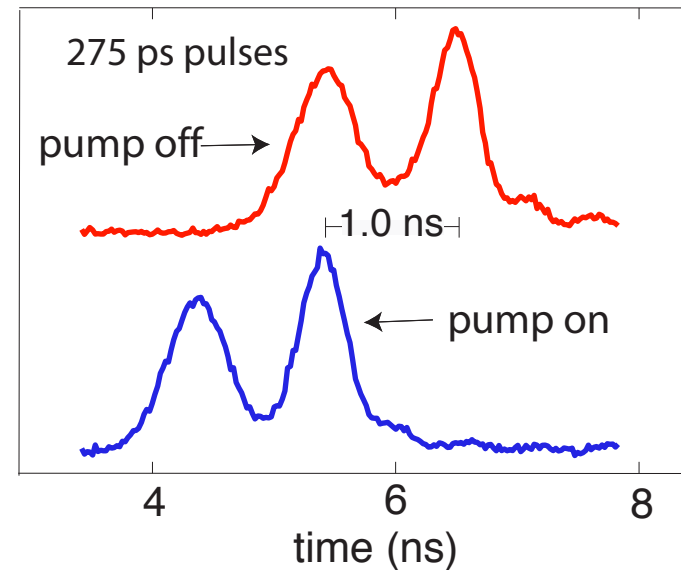

Tunable Delays of up to 80 Pulse Widths in Atomic Cesium Vapor

Comment: In EIT based slow light, spectral reshaping is the dominant limitation. But far off resonance, this effect is negligible. Group velocity dispersion becomes important.

Longer input pulses lead to reduced gvd distortion and longer fractional delays

Results for 740 ps pulses

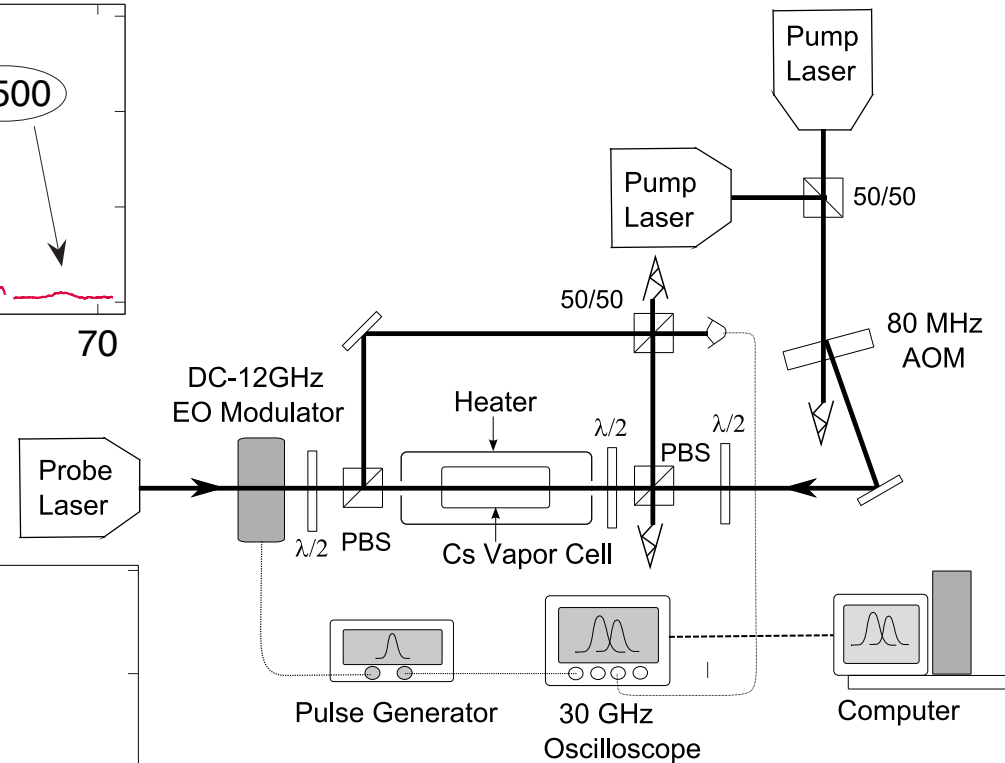
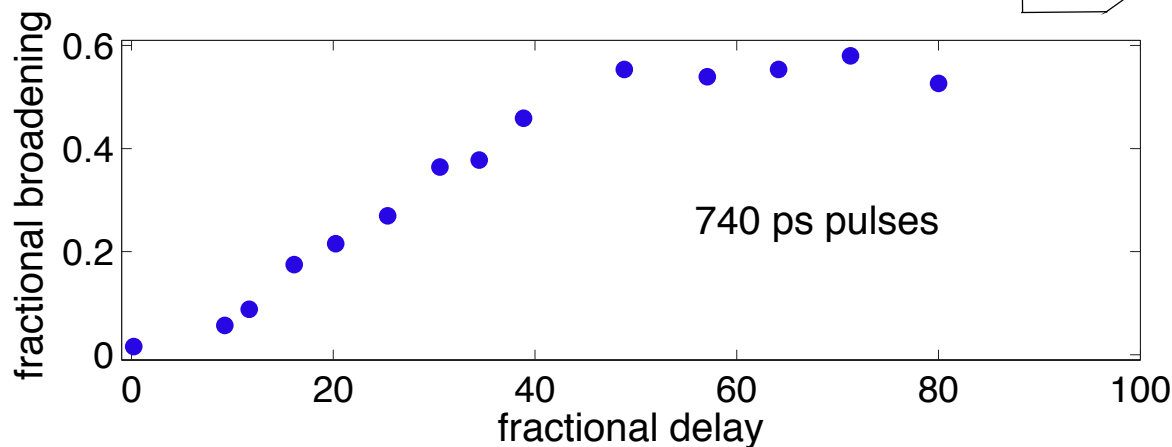
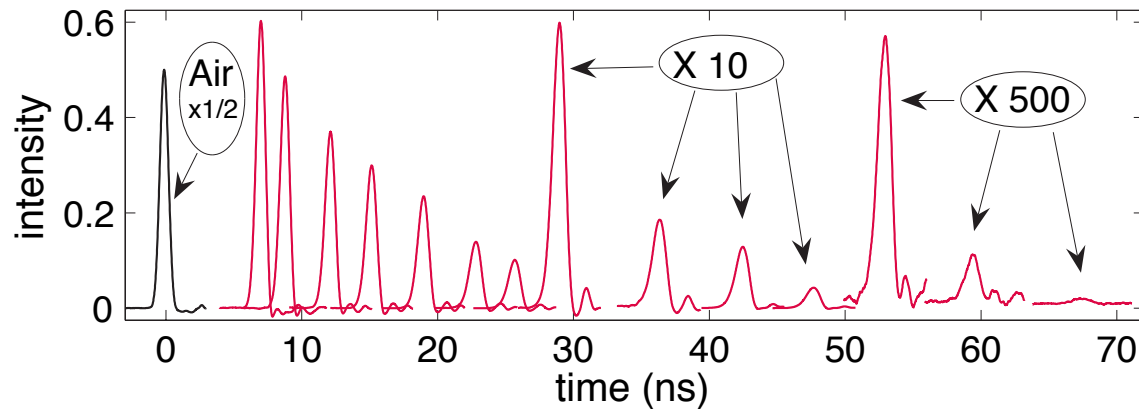

Slow-Light via Stimulated Brillouin Scattering

- Rapid spectral variation of the refractive response associated with SBS gain leads to slow light propagation
- Supports bandwidth of 100 MHz, large group delays
- Even faster modulation for SRS

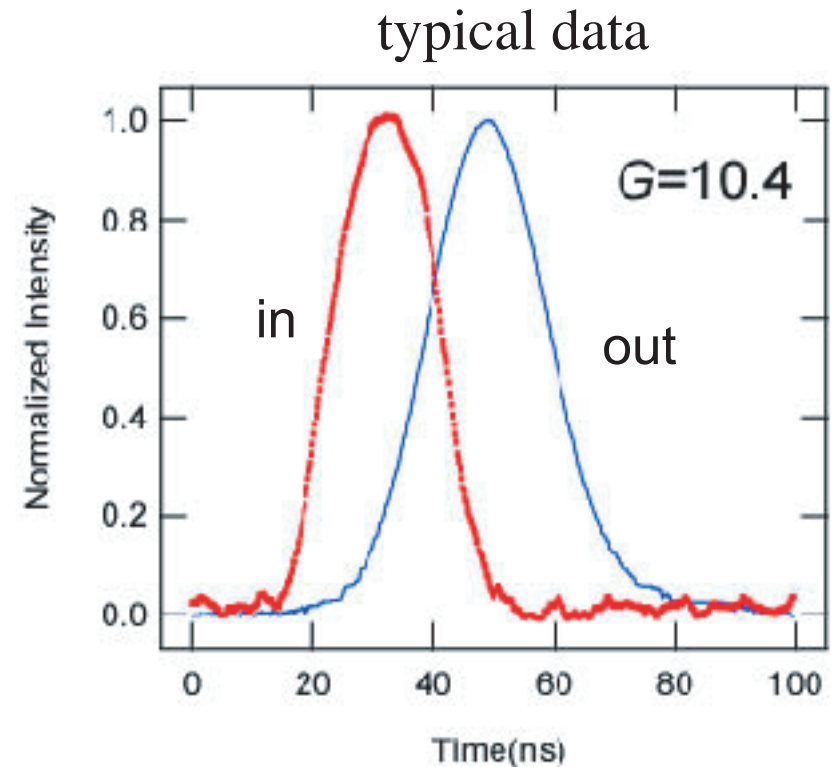
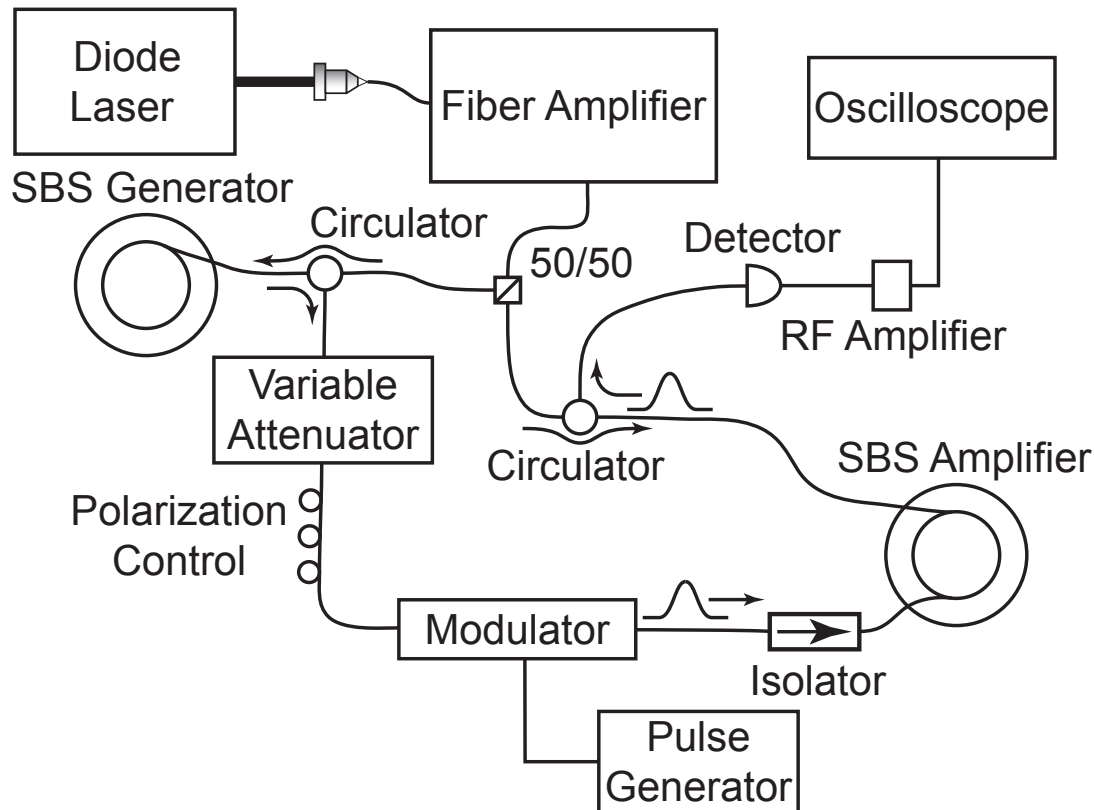



- Use of a flattened gain line leads to significantly improved performance.
- Double gain line can cancel lowest-order contribution to pulse distortion

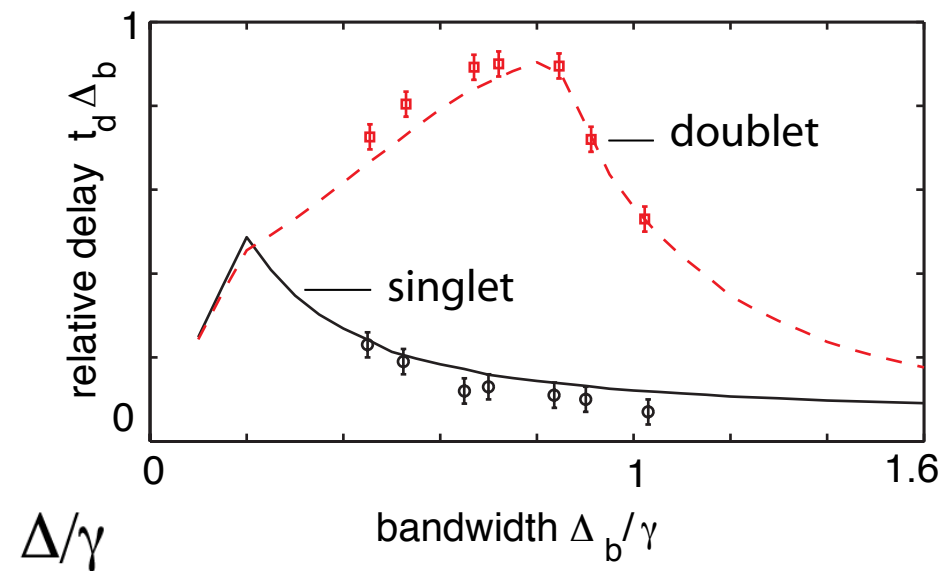
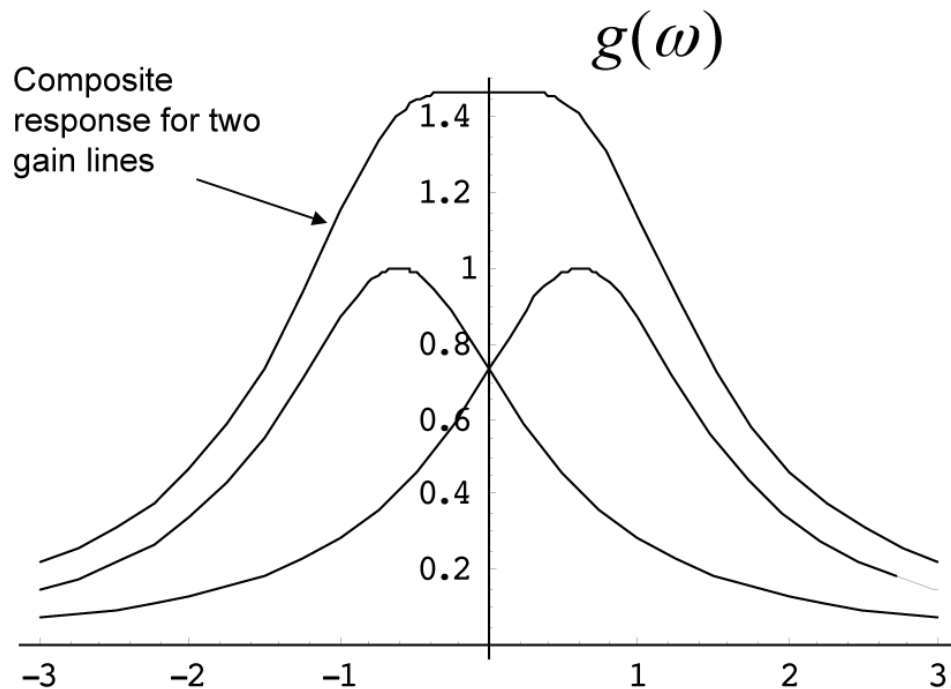

How to Prevent Pulse Distortion (Which Can Limit Data Rates)

Two primary mechanisms for pulse distortion in EDFA

- Spectral broadening, leading to **temporal compression**
CPO gain dip causes spectral components in the wings to be amplified more than central components

- Temporal gain recovery, leading to **temporal broadening**
Leading edge of signal pulse saturates gain, but for long pulses, the trailing edge can experience recovered gain

To minimize second effect, add a cw background to reduce the influence of gain recovery

For the proper choice of background power, the two effects exactly cancel!

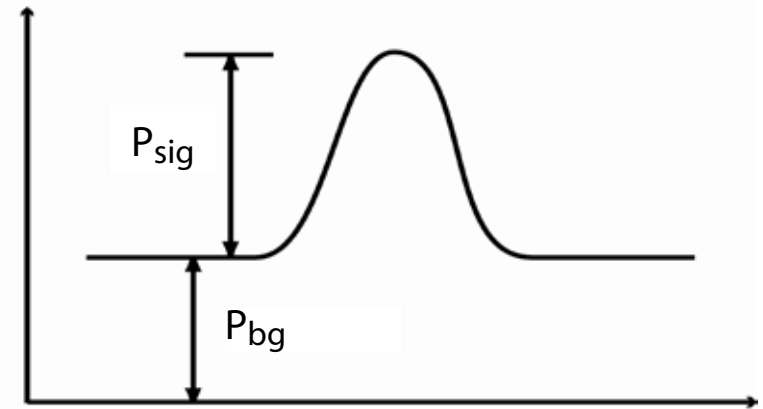

Minimizing Pulse Distortion — Laboratory Results

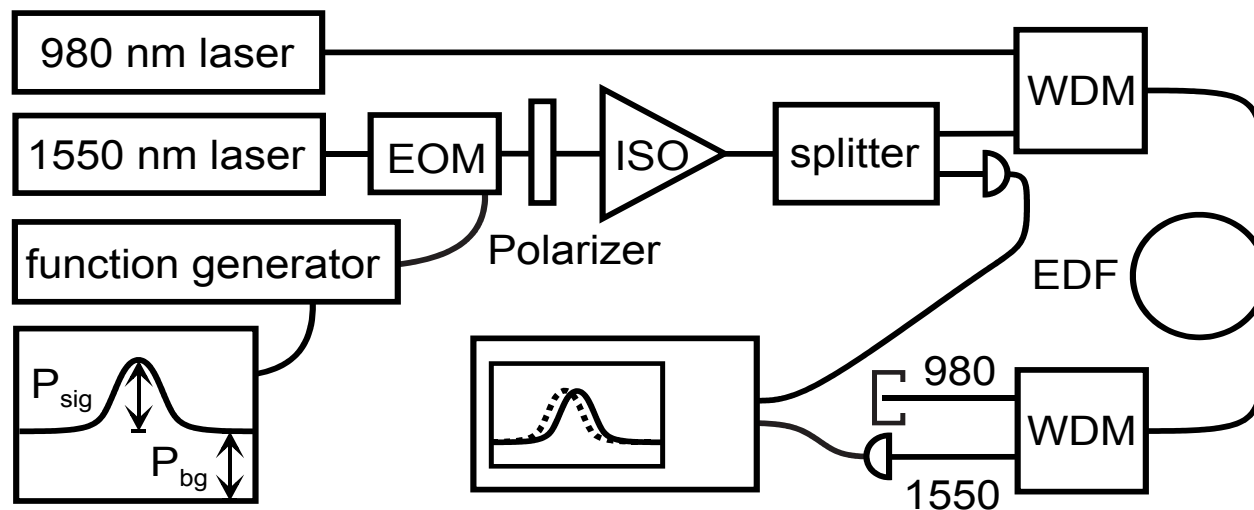

broadening

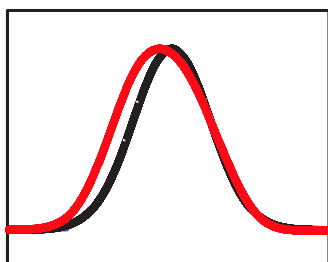

compression

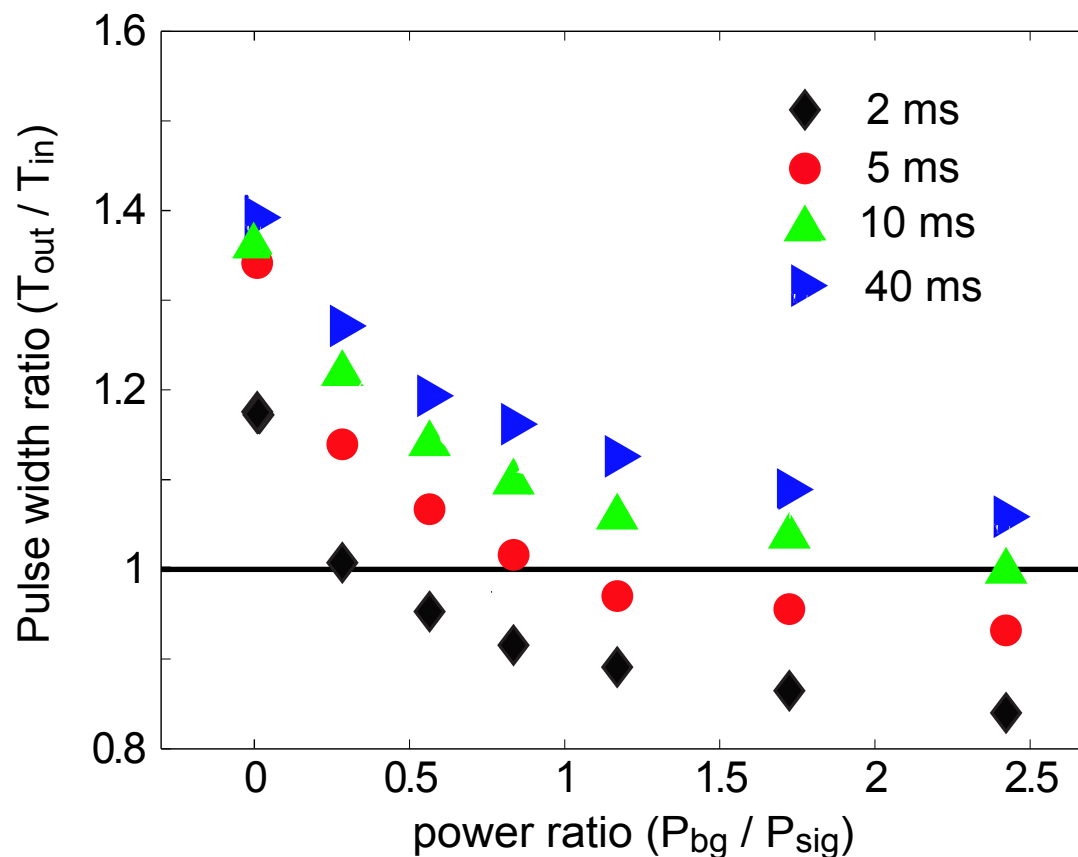
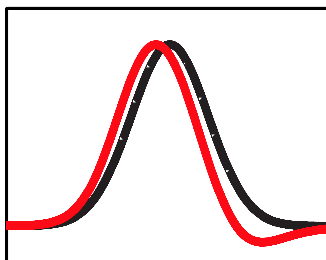



Slow Light in SC Quantum Dot Structures



PbS Quantum Dots (2.9 nm diameter) in liquid solution

Excite with 16 ps pulses at 795 nm; observe 3 ps delay

30 ps response time (literature value)

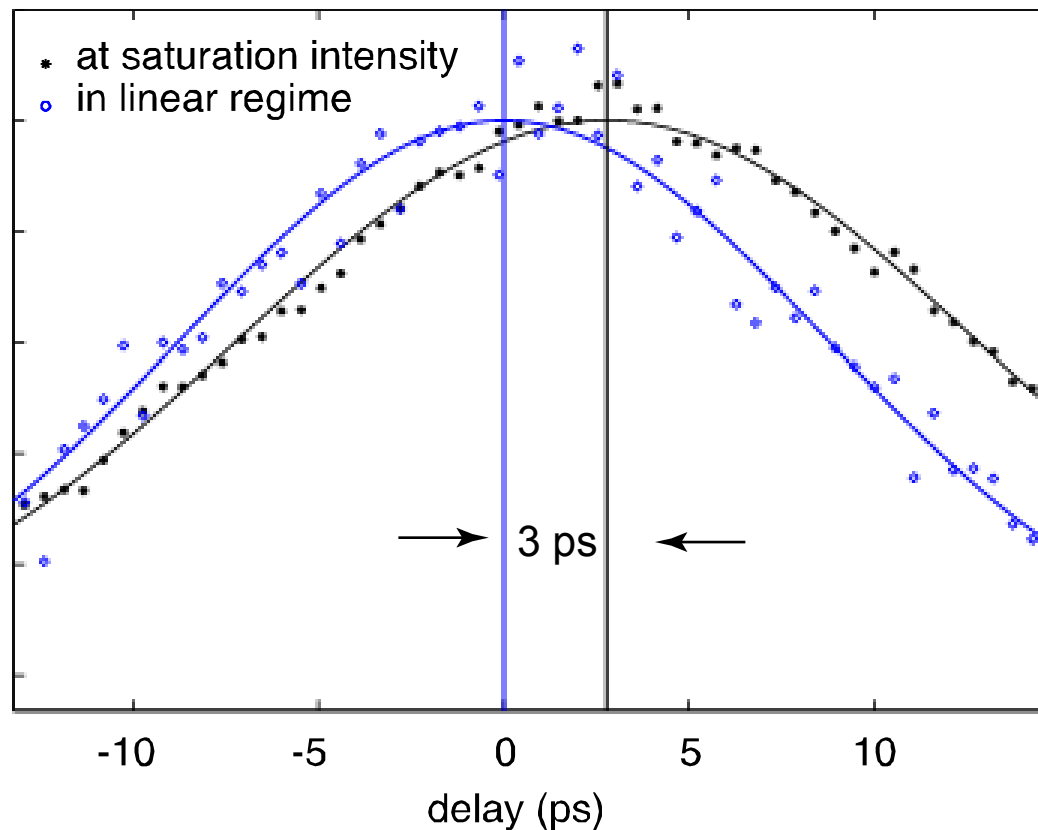

Summary

Slow-light techniques hold great promise for applications in telecommunications

Good progress being made in developing new slow-light techniques and applications

Backwards and superluminal propagation are strongly counterintuitive, but are fully explained by standard physics.

Special Thanks to My Students and Research Associates

