

Progress in Slow Light and Quantum Imaging

Robert W. Boyd

Institute of Optics and
Department of Physics and Astronomy
University of Rochester

with Aaron Schweinsberg, Hye Jeong Chang, Colin O'Sullivan-Hale
Petros Zerom, Giovanni Piredda, Zhimin Shi, Heedeuk Shin, and others.

Presented at What's Up in Optics, November 10, 2005.

Special Thanks to My Students and Research Associates

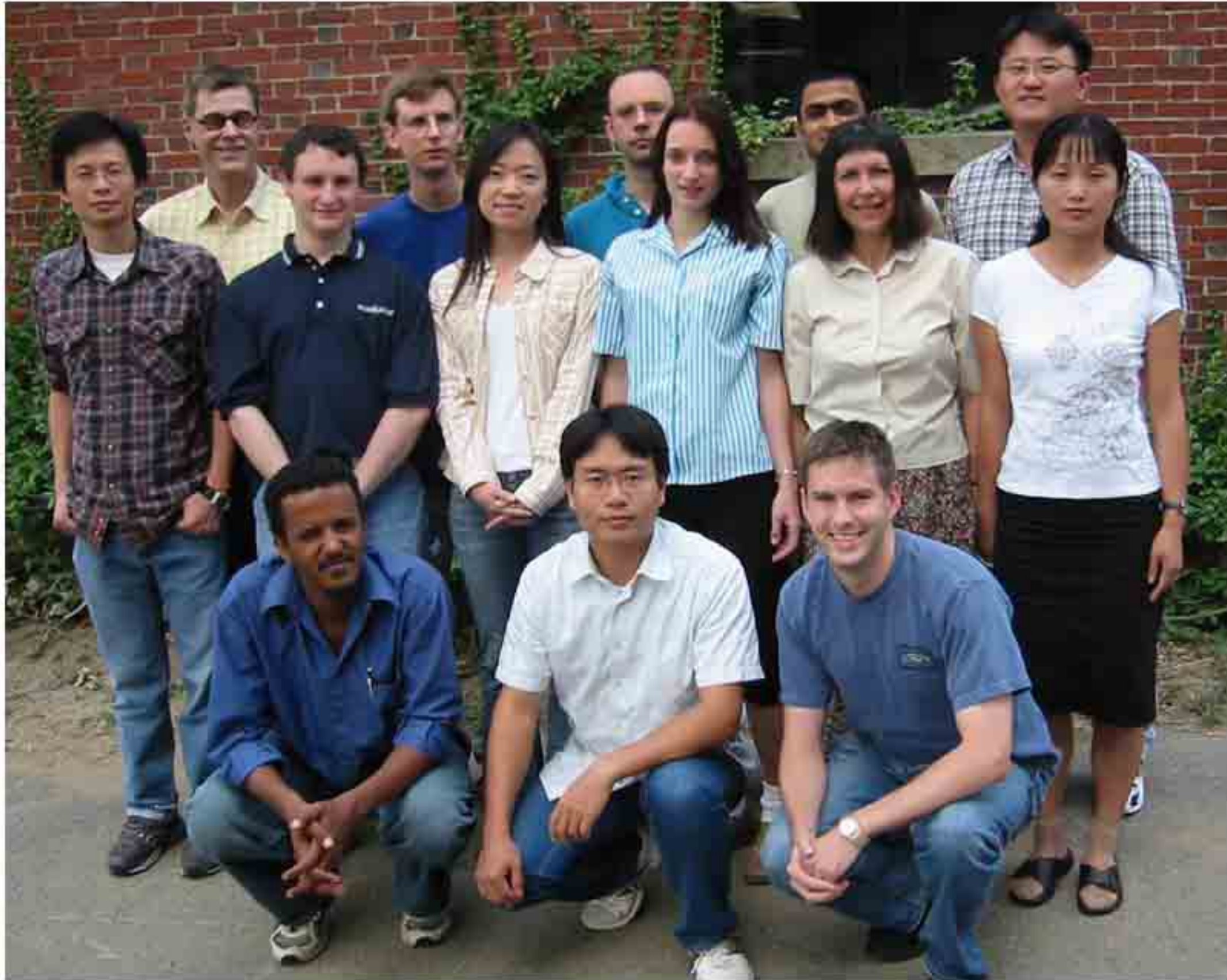

Interest in Slow Light

Intrigue: Can (group) refractive index really be 10^6 ?

Fundamentals of optical physics

Optical delay lines, optical storage, optical memories

Implications for quantum information

And what about fast light ($v > c$ or negative)?

Boyd and Gauthier, "Slow and Fast Light," in Progress in Optics, 43, 2002.

Review of Slow-Light Fundamentals

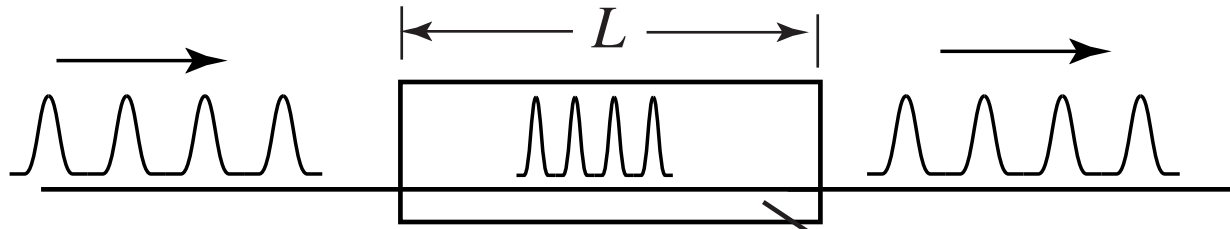

group velocity: $v_g = \frac{c}{n_g}$

group index: $n_g = n + \omega \frac{dn}{d\omega}$

group delay: $T_g = \frac{L}{v_g} = \frac{Ln_g}{c}$

controllable delay: $T_{\text{del}} = T_g - L/c = \frac{L}{c}(n_g - 1)$

To make controllable delay as large as possible:

- make L as large as possible (reduce residual absorption)
- maximize the group index



All-Optical Switch

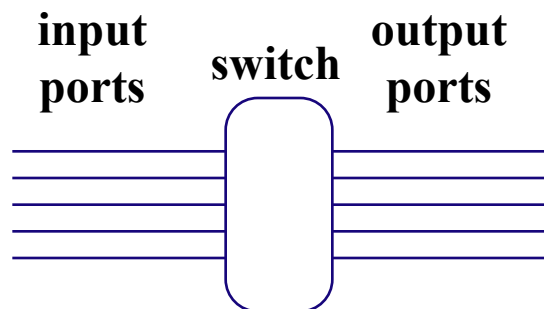

Use Optical Buffering to Resolve Data-Packet Contention

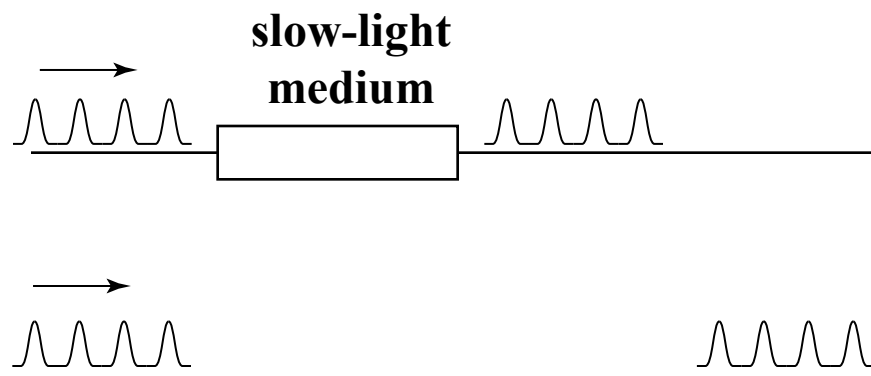

But what happens if two data packets arrive simultaneously?

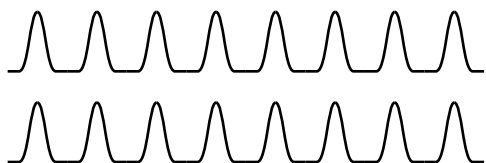

Controllable slow light for optical buffering can dramatically increase system performance.

Challenge/Goal

Slow light in a room-temperature solid-state material.

Our approaches:

1. Stimulated Brillouin Scattering
2. Stimulated Raman Scattering
3. Wavelength Conversion and Dispersion
4. Coherent Population Oscillations
 - a. Ruby and alexandrite
 - b. Semiconductor quantum dots (PbS)
 - c. Semiconductor optical amplifier
 - d. Erbium-doped fiber amplifier

Also: application of slow-light to low-light-level switching

Slow Light in Ruby

Recall that $n_g = n + \omega(dn/d\omega)$. Need a large $dn/d\omega$. (How?)

Kramers-Kronig relations:

Want a very narrow feature in absorption line.

Well-known “trick” for doing so:

Make use of spectral holes due to population oscillations.

Hole-burning in a homogeneously broadened line; requires $T_2 \ll T_1$.

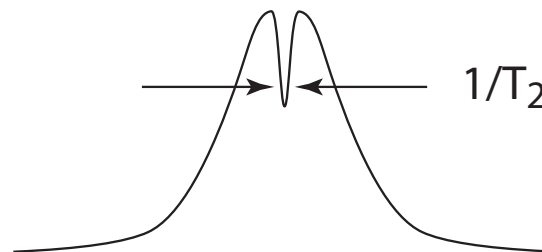

inhomogeneously
broadened medium

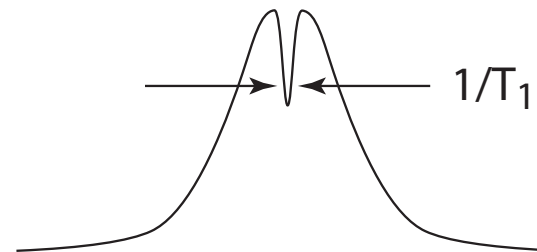

homogeneously
broadened medium
(or inhomogeneously
broadened)

Slow Light Experimental Setup

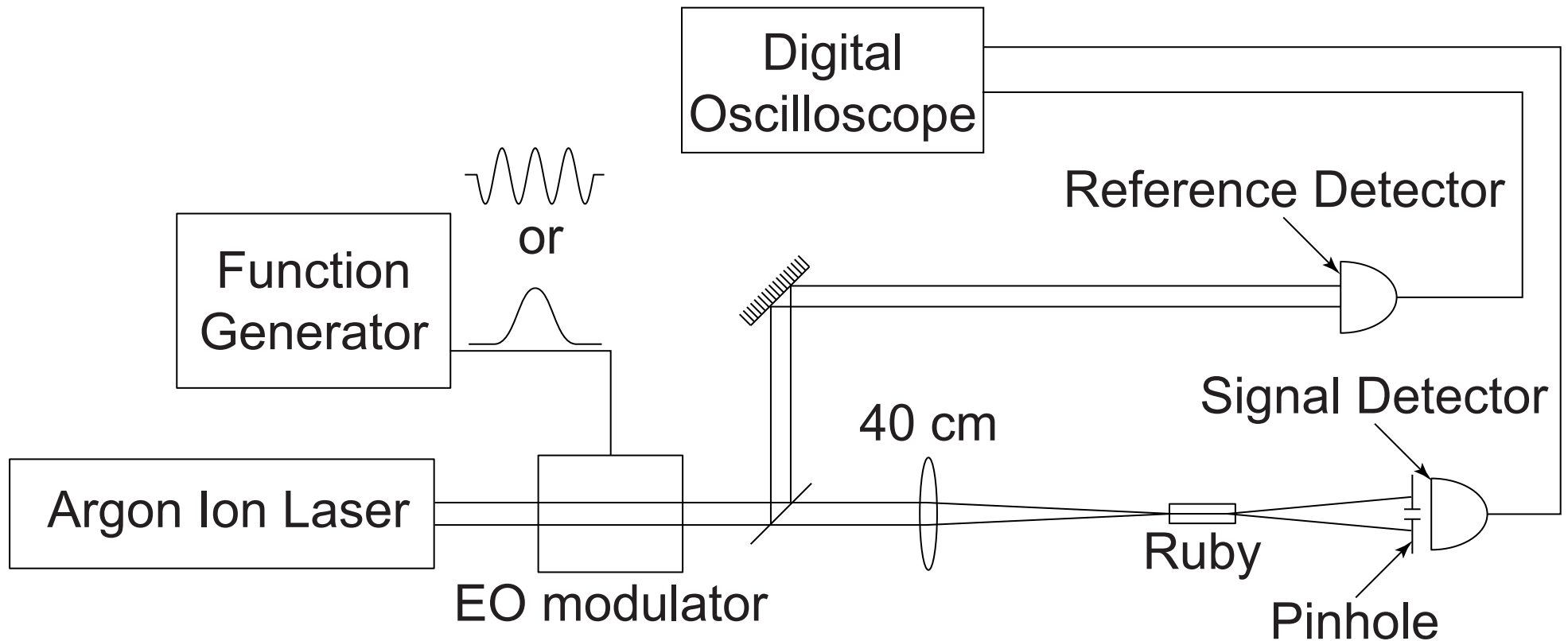

7.25-cm-long ruby laser rod (pink ruby)

Gaussian Pulse Propagation Through Ruby

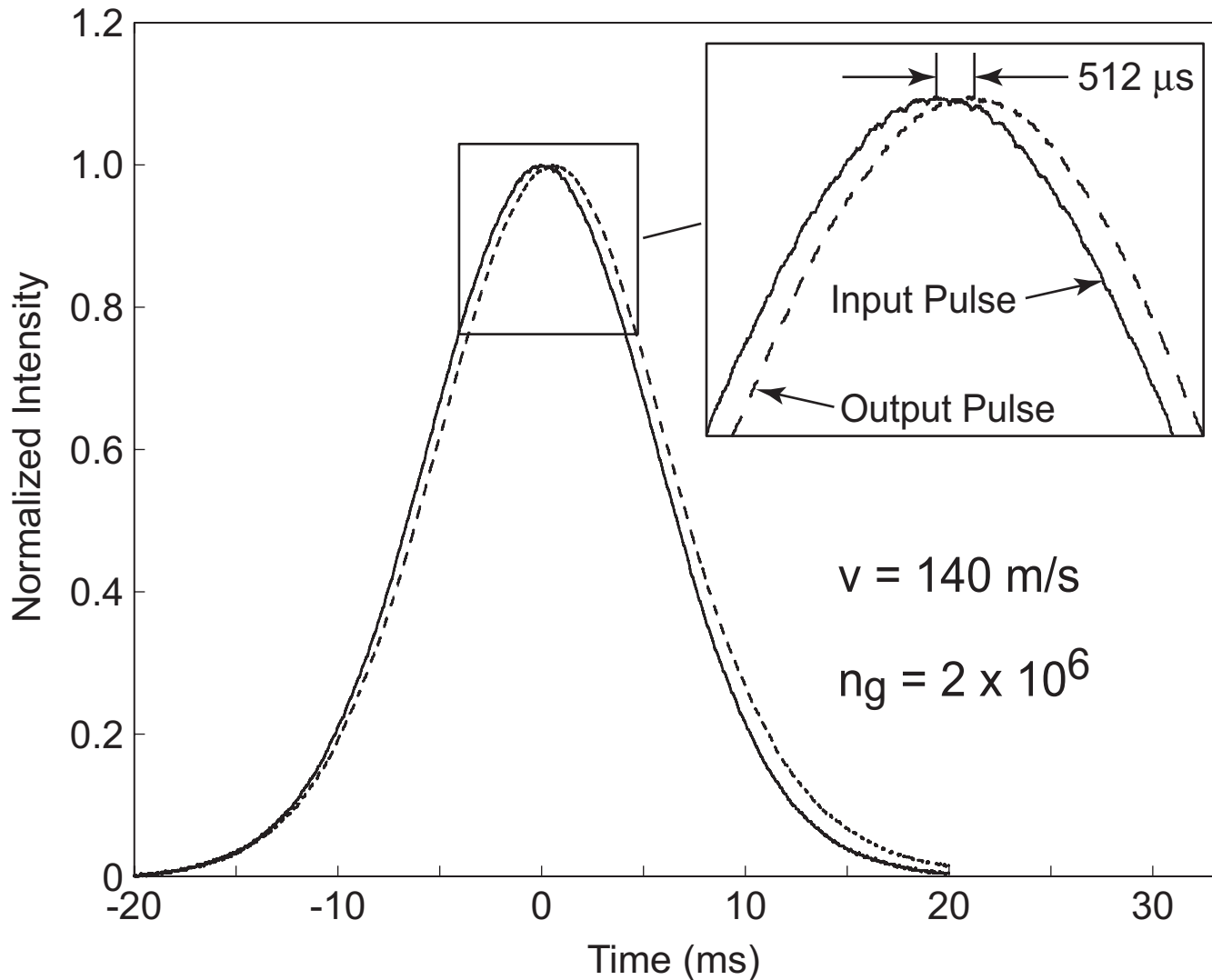

No pulse distortion!

Matt Bigelow and Nick Lepeshkin in the Lab

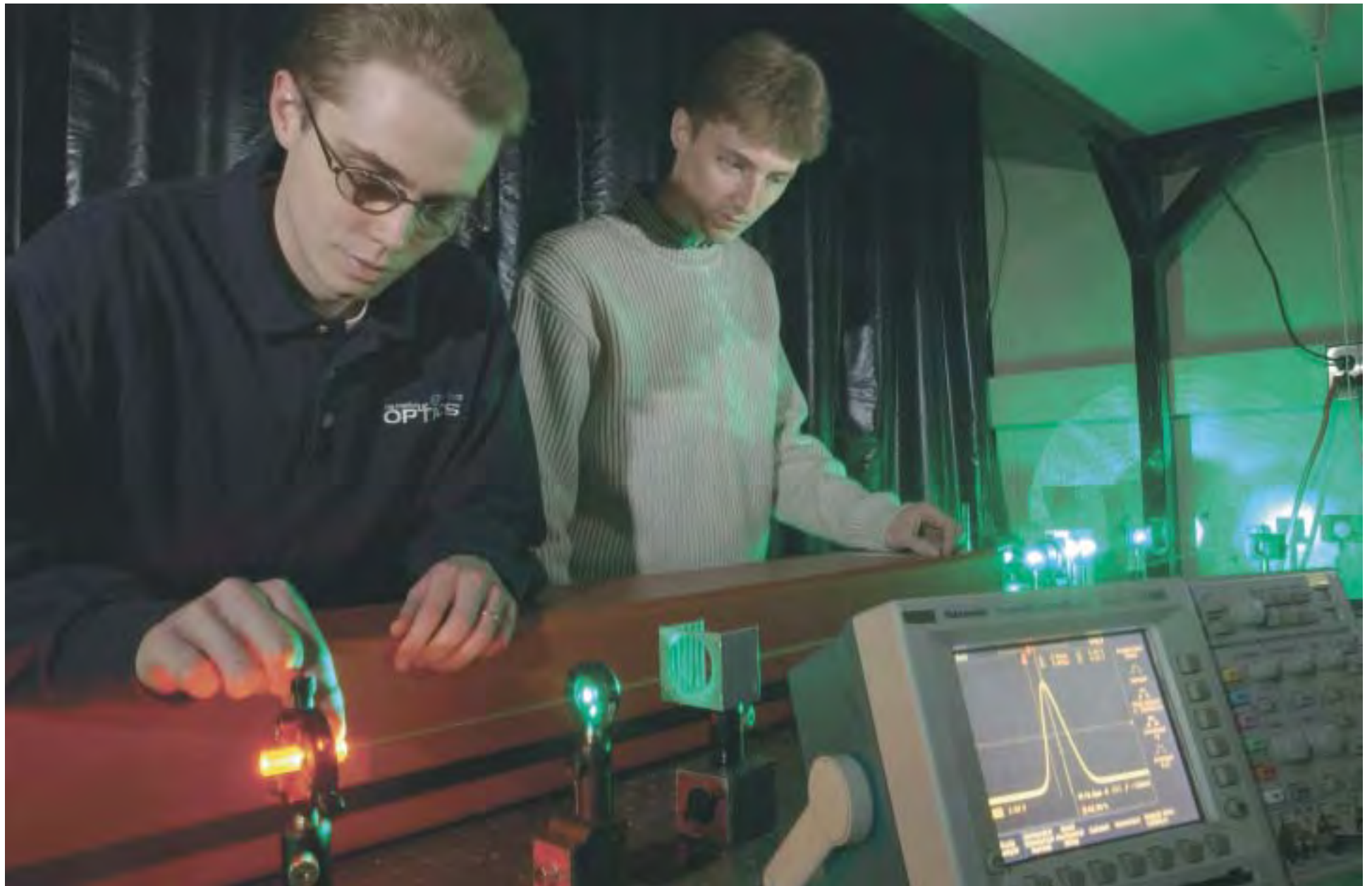

Alexandrite Displays both Saturable and Reverse-Saturable Absorption

- Both slow and fast propagation observed in alexandrite

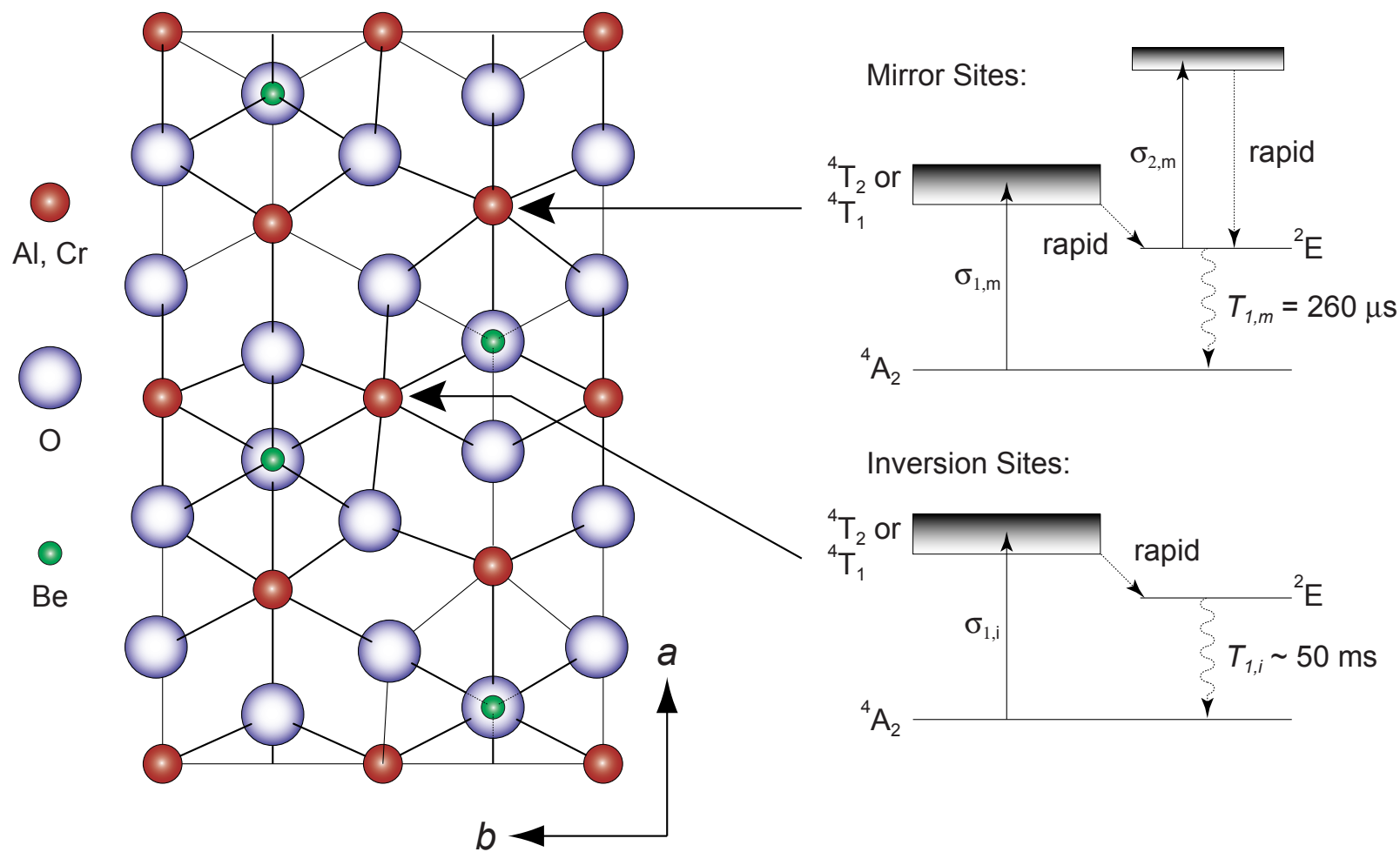

Inverse-Saturable Absorption Produces Superluminal Propagation in Alexandrite

At 476 nm, alexandrite is an inverse saturable absorber

Negative time delay of 50 μs corresponds to a velocity of -800 m/s

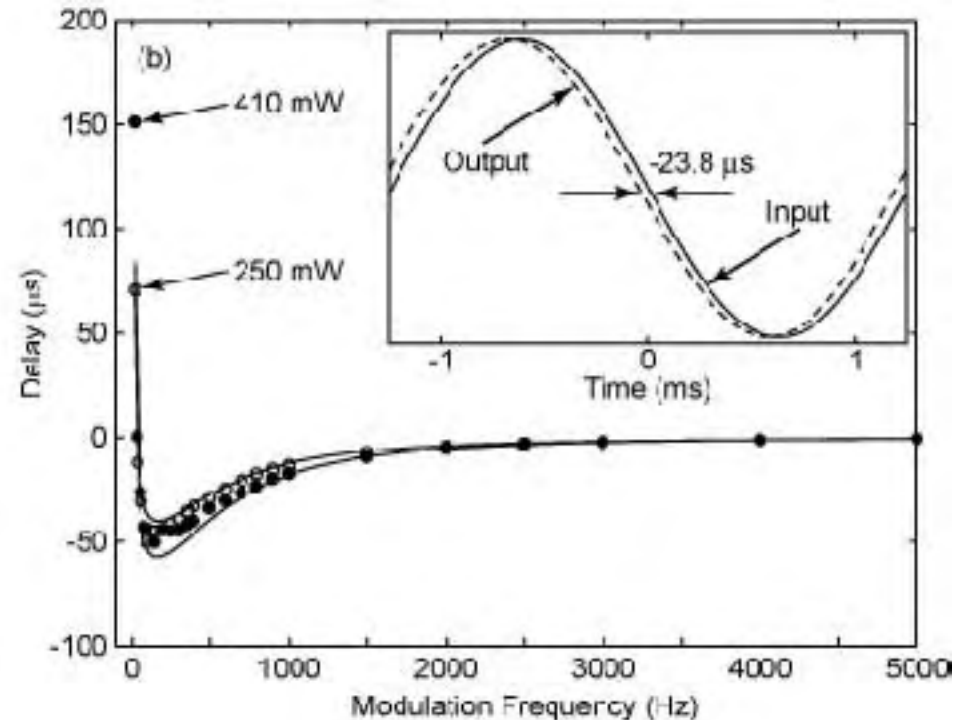
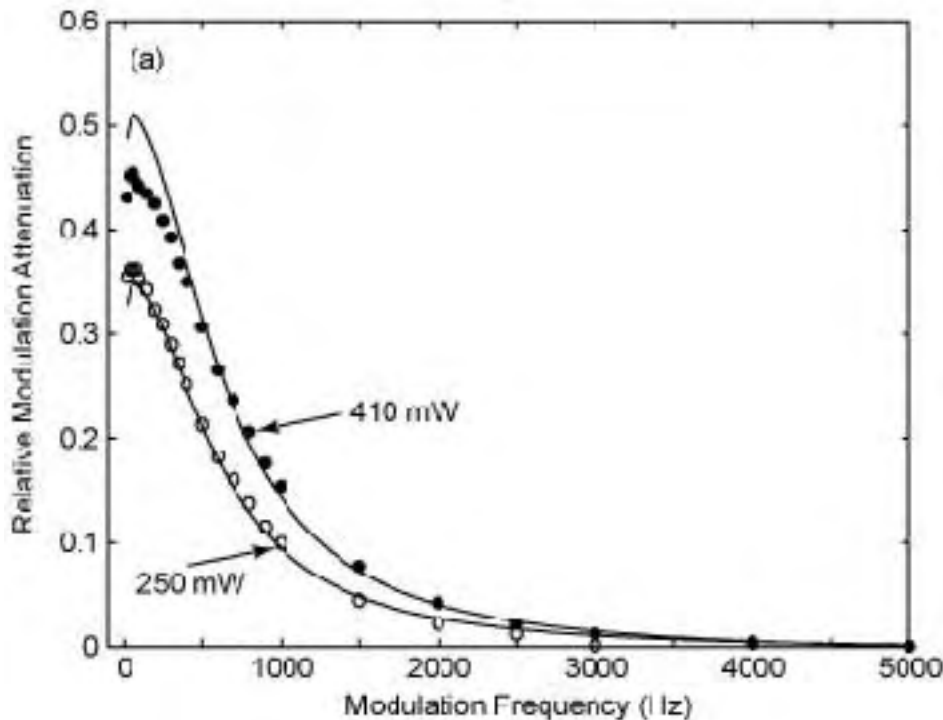

M. Bigelow, N. Lepeshkin, and RWB, Science, 2003

Numerical Modeling of Pulse Propagation Through Slow and Fast-Light Media

Numerically integrate the paraxial wave equation

$$\frac{\partial A}{\partial z} - \frac{1}{v_g} \frac{\partial A}{\partial t} = 0$$

and plot $A(z,t)$ versus distance z .

Assume an input pulse with a Gaussian temporal profile.

Study three cases:

Slow light $v_g = 0.5 c$

Fast light $v_g = 5 c$ and $v_g = -2 c$

Pulse Propagation through a Slow-Light Medium ($n_g = 2$, $v_g = 0.5 c$)

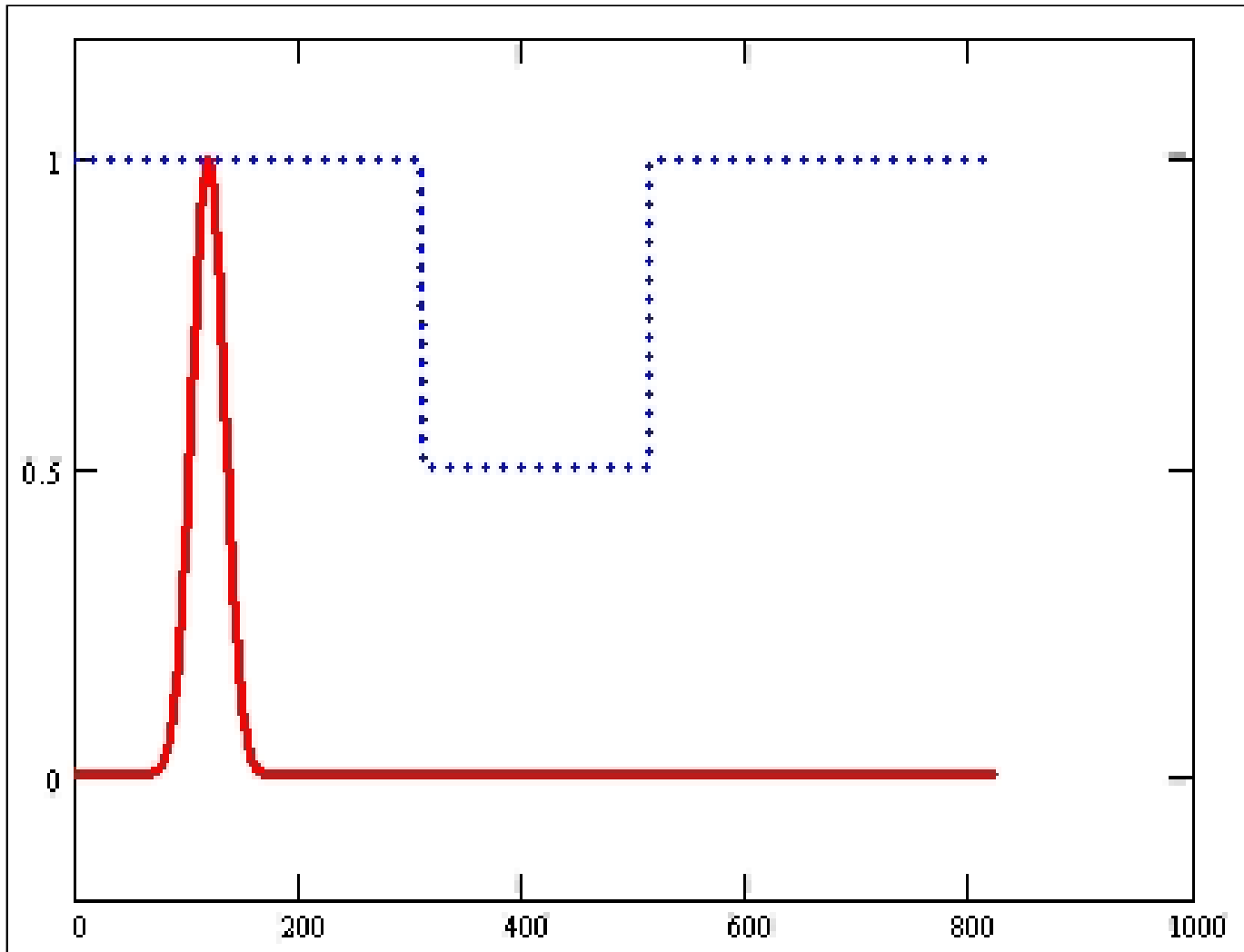

Pulse Propagation through a Fast-Light Medium ($n_g = .2$, $v_g = 5 c$)

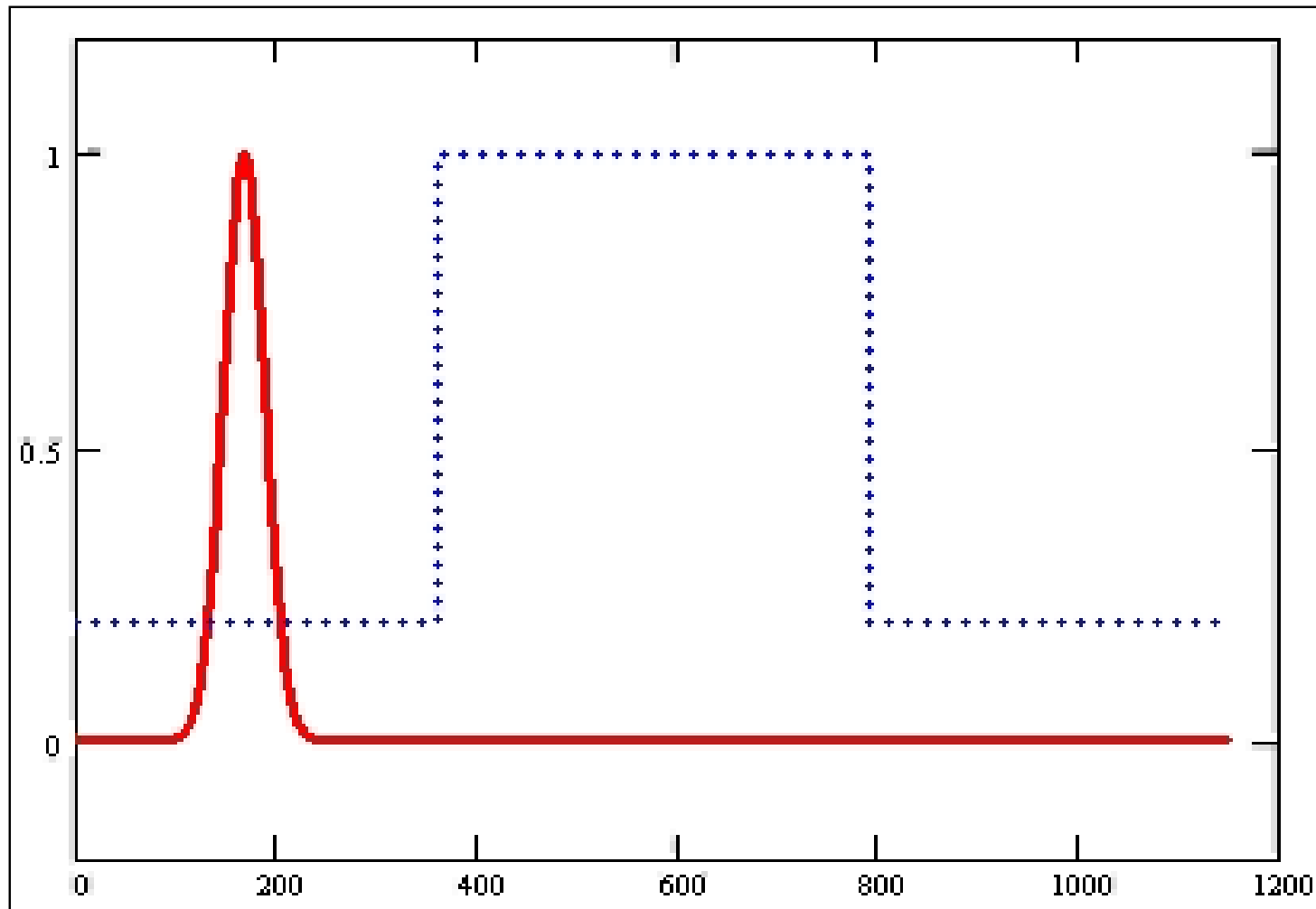

Pulse Propagation through a Fast-Light Medium ($n_g = -.5$, $v_g = -2 c$)

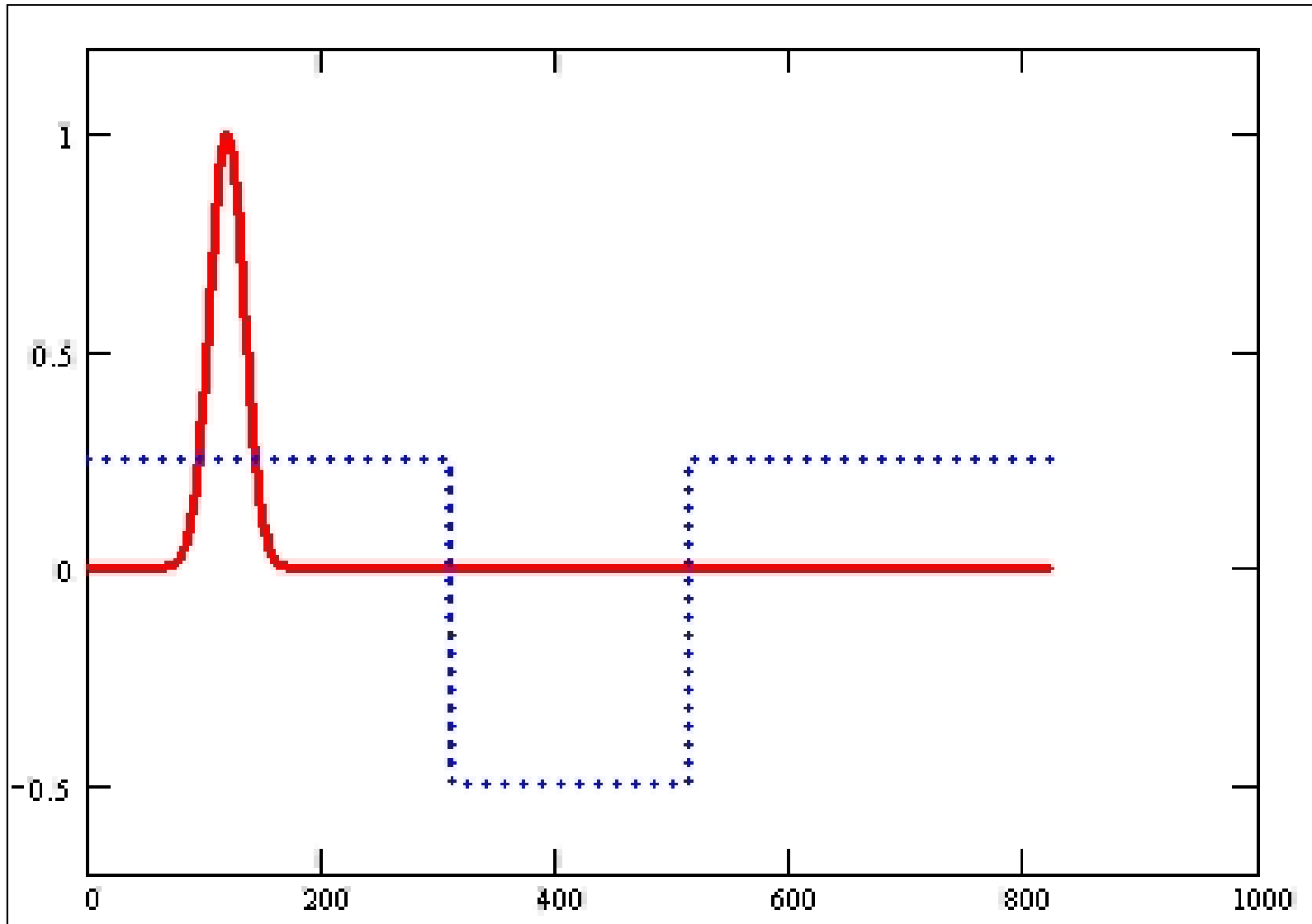

Some New Results

Slow and Fast Light in an Erbium Doped Fiber Amplifier

- Fiber geometry allows long propagation length
- Saturable gain or loss possible depending on pump intensity

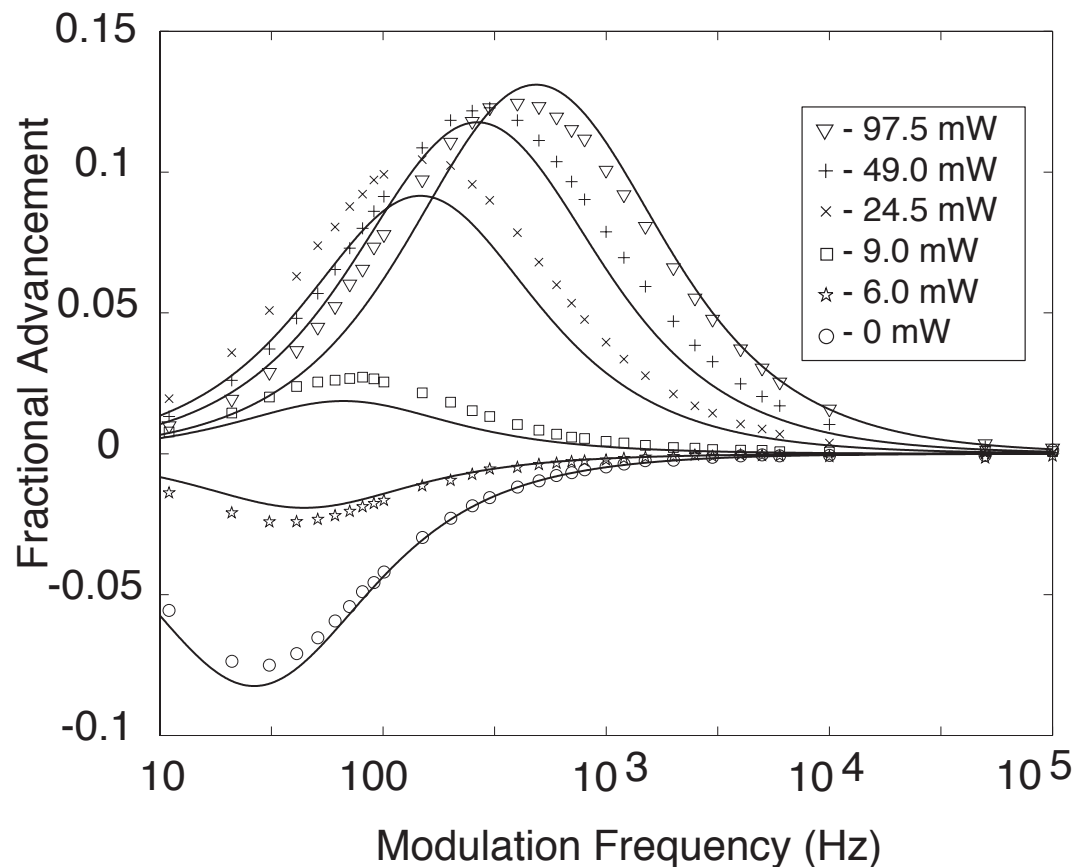
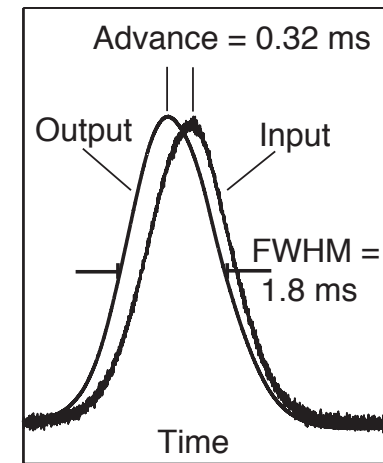
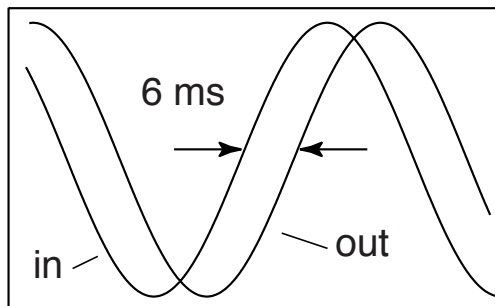
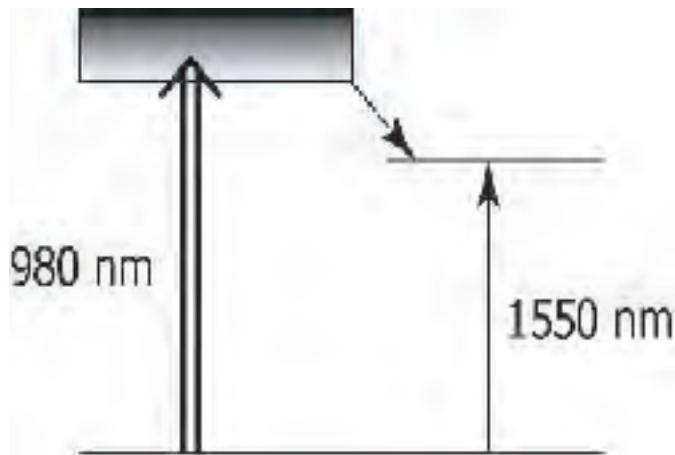

Research in Quantum Imaging

Can images be formed with higher resolution or better sensitivity through use of quantum states of light?

Can we "beat" the Rayleigh criterion?

Quantum states of light: For instance, squeezed light or entangled beams of light.

Progress in Quantum Lithography

Robert W. Boyd, Sean J. Bentley,
Hye Jeong Chang, and Malcolm N. O'Sullivan-Hale

Institute of Optics, University of Rochester,
Rochester NY, USA

Quantum Lithography

- Entangled photons can be used to form an interference pattern with detail finer than the Rayleigh limit
- Process “in reverse” performs sub-Rayleigh microscopy, etc.
- Resolution $\approx \lambda / 2N$, where N = number of entangled photons

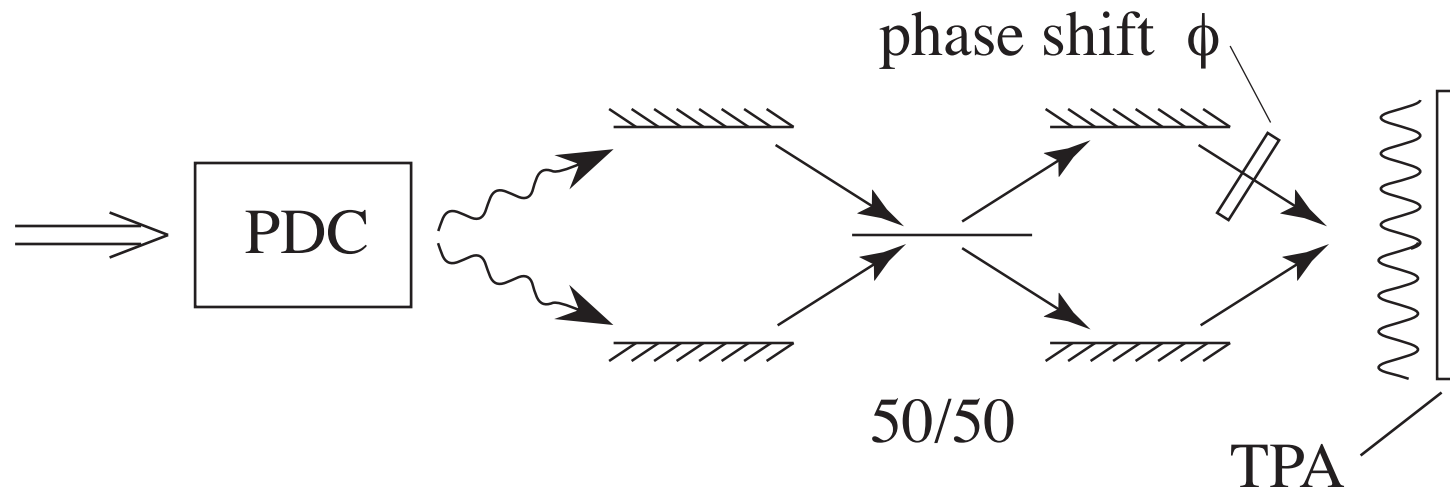

Boto et al., Phys. Rev. Lett. 85, 2733, 2000.

("al." includes Jon Dowling)

Quantum Lithography: Easier Said Than Done

- Need an intense source of individual biphotons (Inconsistency?)
Maybe a high-gain OPA provides the best tradeoff between high intensity and required quantum statistics

- Need an N -photon recording material

For proof-of-principle studies, can use N -th-harmonic generator, correlation circuitry, N -photon photodetector.

For actual implementation, use ????

Maybe best bet is UV lithographic material excited in the visible or a broad bandgap material such as PMMA excited by multiphoton absorption.

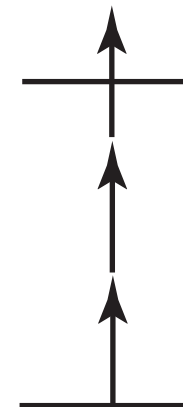

3PA in PMMA
breaks chemical
bond, modifying
optical properties.

Non-Quantum Quantum Lithography

Concept: average M shots with the phase of shot k given by $2\pi k/M$

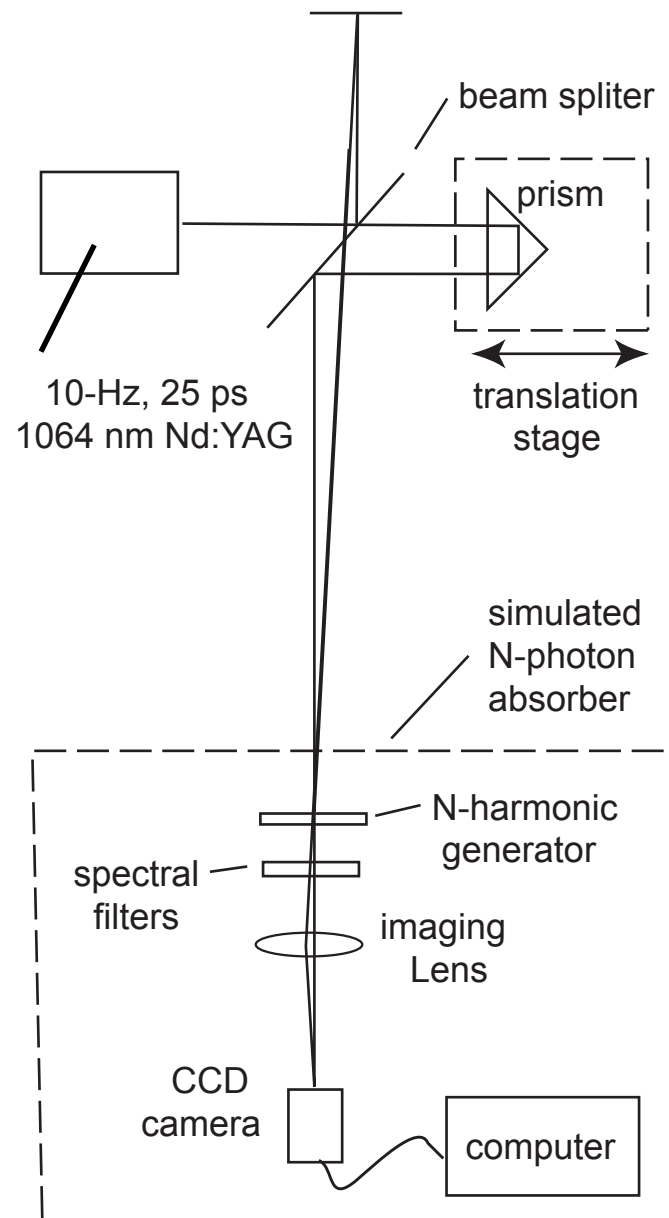
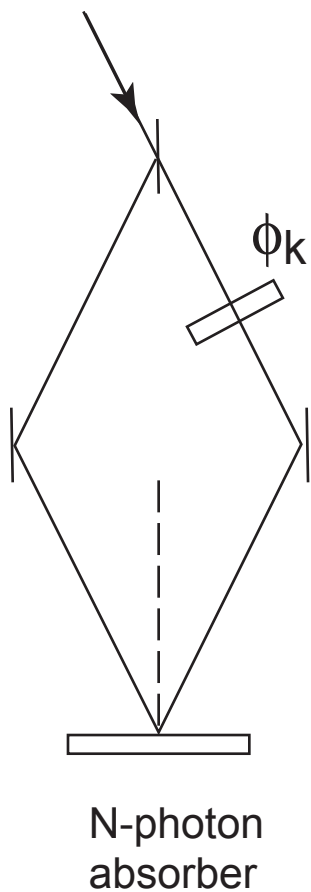

$N=1, M=1$

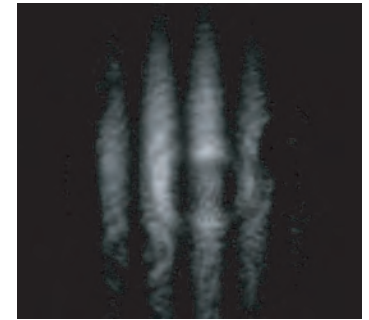

$N=2, M=1$

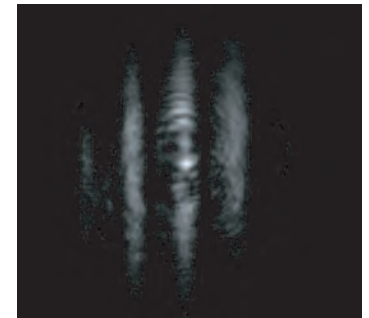

$N=2, M=2$

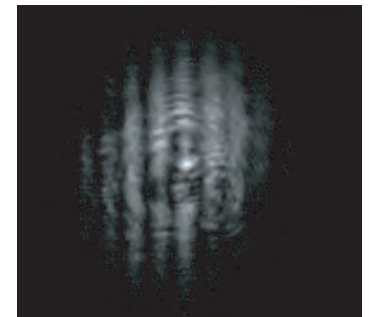

Spatial Resolution of Various Systems

- **Linear optical medium**

$$E = 1 + \cos kx$$

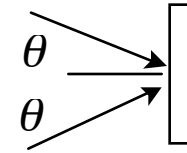

- **Two-photon absorbing medium, classical light**

$$E = (1 + \cos kx)^2 = 1 + 2 \cos kx + \cos^2 kx$$
$$= 3/2 + 2 \cos kx + (1/2) \cos 2kx$$

- **Two-photon absorbing medium, entangled photons**

$$E = 1 + \cos 2kx$$

where $k = 2(\omega/c) \sin \theta$

Demonstration of Fringes Written into PMMA

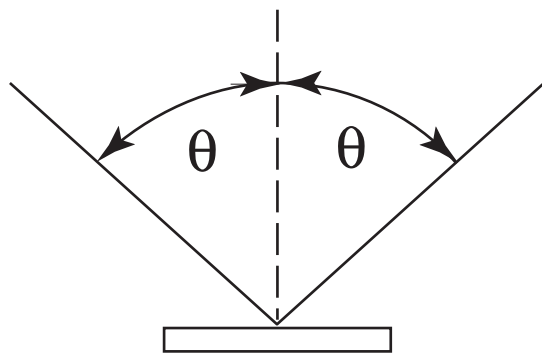

N-photon absorber
(N = 3 ?)

$\theta = 70$ degrees
write wavelength = 800 nm
pulse energy = 130 μ J per beam
pulse duration = 120 fs
period = $\lambda / (2 \sin \theta) = 425$ nm

PMMA on glass substrate
develop for 10 sec in MBIK
rinse 30 sec in deionized water



AFM

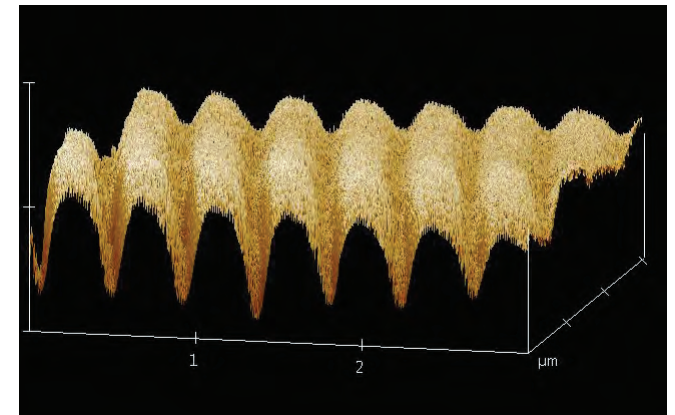
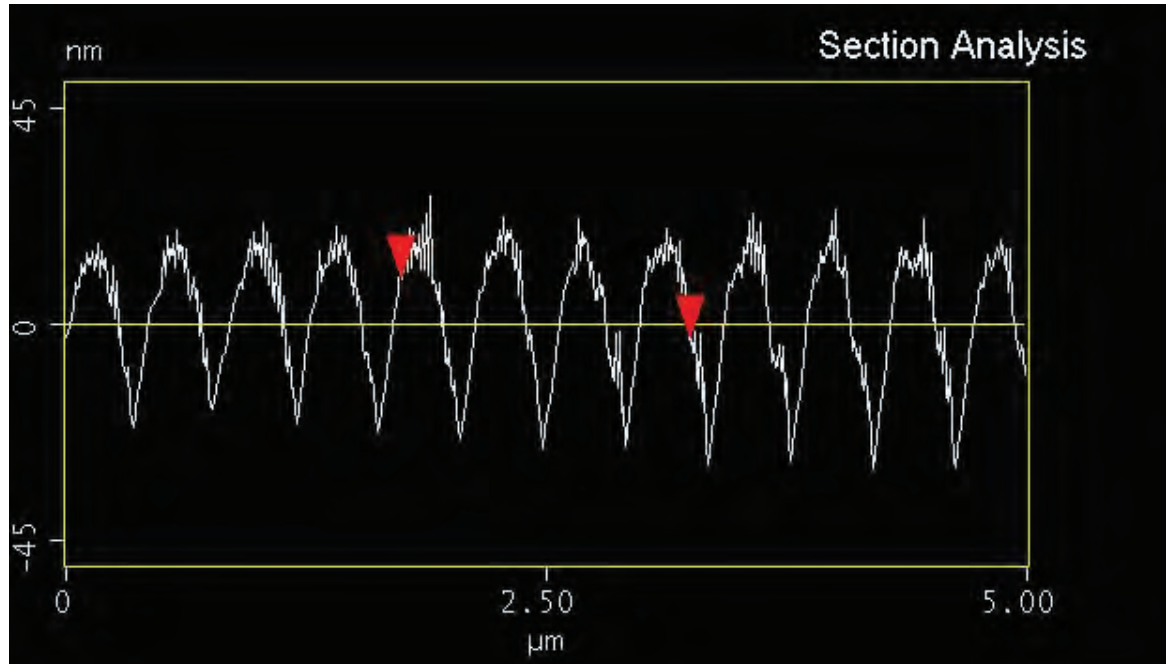

PMMA is a standard lithographic material

Demonstration of Sub-Rayleigh Fringes (Period = $\lambda/4$)

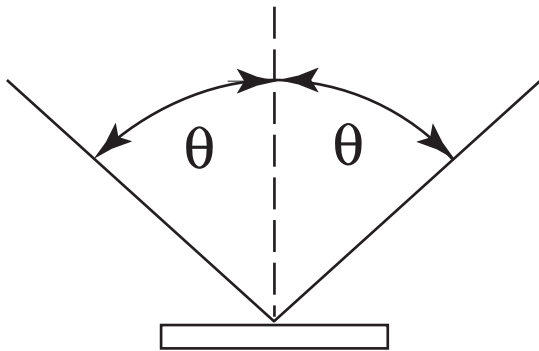

N-photon absorber

$\theta = 70$ degrees

two pulses with 180 deg phase shift

write wavelength = 800 nm

pulse energy = 90 μ J per beam

fundamental period = $\lambda / (2 \sin \theta) = 425$ nm

period of written grating = 212 nm

PMMA on glass substrate

develop for 10 sec in MBIK

rinse 30 sec in deionized water

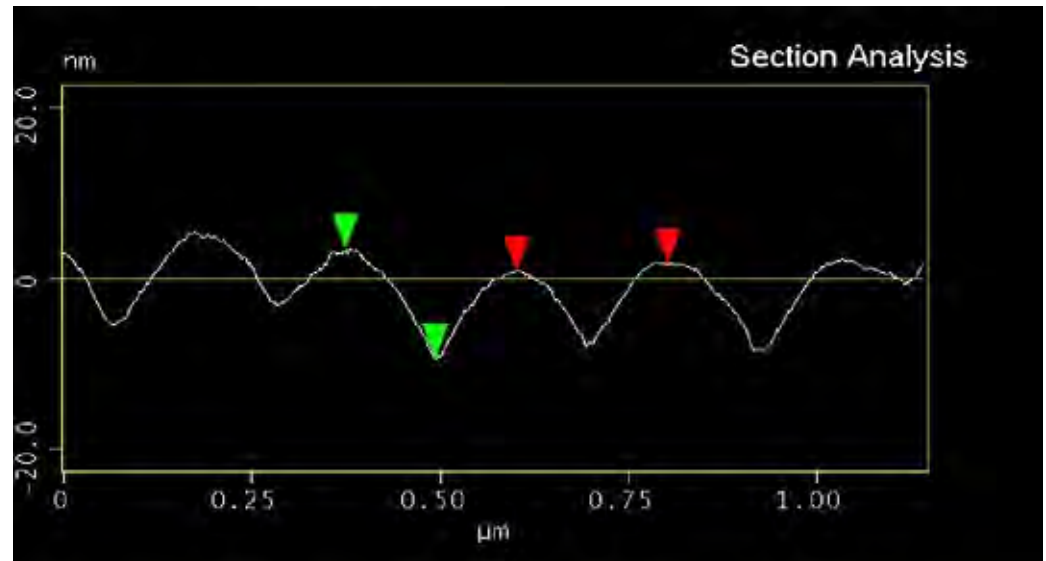
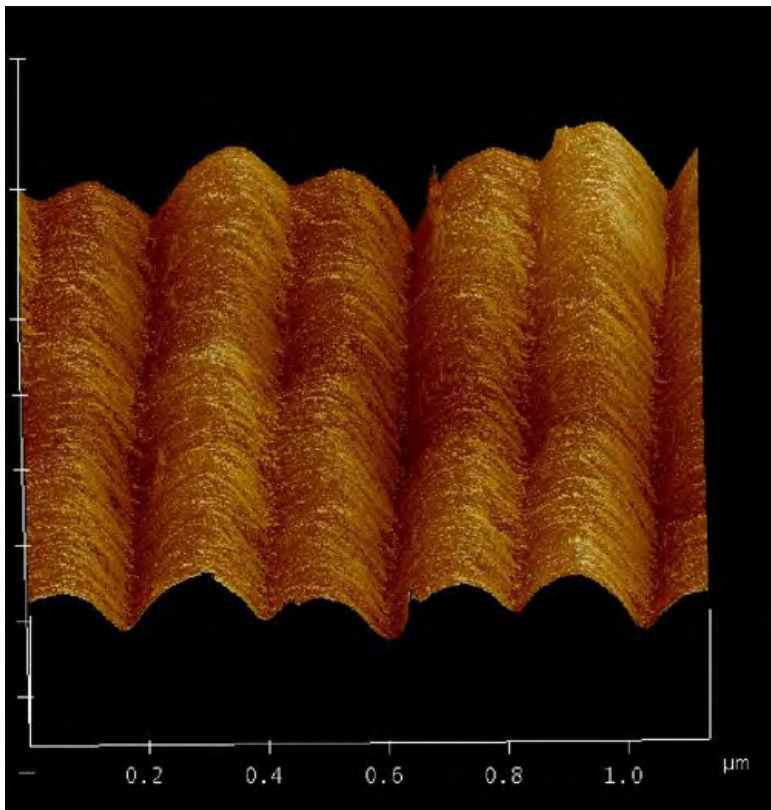

Significance of PMMA Grating Results

- Provides an actual demonstration of sub-Rayleigh resolution by the phase-shifted grating method
- Demonstrates an N-photon absorber with adequate resolution to be of use in true quantum lithography

Quantum Lithography Prospects

Quantum lithography (as initially proposed by Dowling) has a good chance of becoming a reality.

Classically simulated quantum lithography may be a realistic alternative approach, and one that is much more readily implemented.

Thank you for your attention!

Our results are posted on the web at:

<http://www.optics.rochester.edu/~boyd>