

Quantum Imaging: New Methods and Applications

Robert W. Boyd

The Institute of Optics and
Department of Physics and Astronomy
University of Rochester, Rochester, NY 14627
<http://www.optics.rochester.edu>

Presented at Louisiana State University, April 5, 2006.

Research in Quantum Imaging

Can images be formed with higher resolution or better sensitivity through use of quantum states of light?

Can we "beat" the Rayleigh criterion?

Quantum states of light: For instance, squeezed light or entangled beams of light.

Outline for this presentation

- Review of nonlinear optical methods for superresolution

- Progress in quantum lithography

- Progress in ghost imaging

NLO and Superresolution

What are the real issues for optical microscopy?

1. Increased transverse resolution

Rayleigh criterion $\Delta x = 0.61 \lambda / (\text{NA})$

NA = numerical aperture = $n \sin \theta$

2. Increased longitudinal resolution

Rayleigh criterion $\Delta z = 2 \lambda / (\text{NA})^2$

(longitudinal resolution typically lower than transverse)

3. Ability to image through scattering medium

Scattering leads to loss of contrast

Scattering gets worse at shorter wavelengths

Methods for Increasing Spatial Resolution

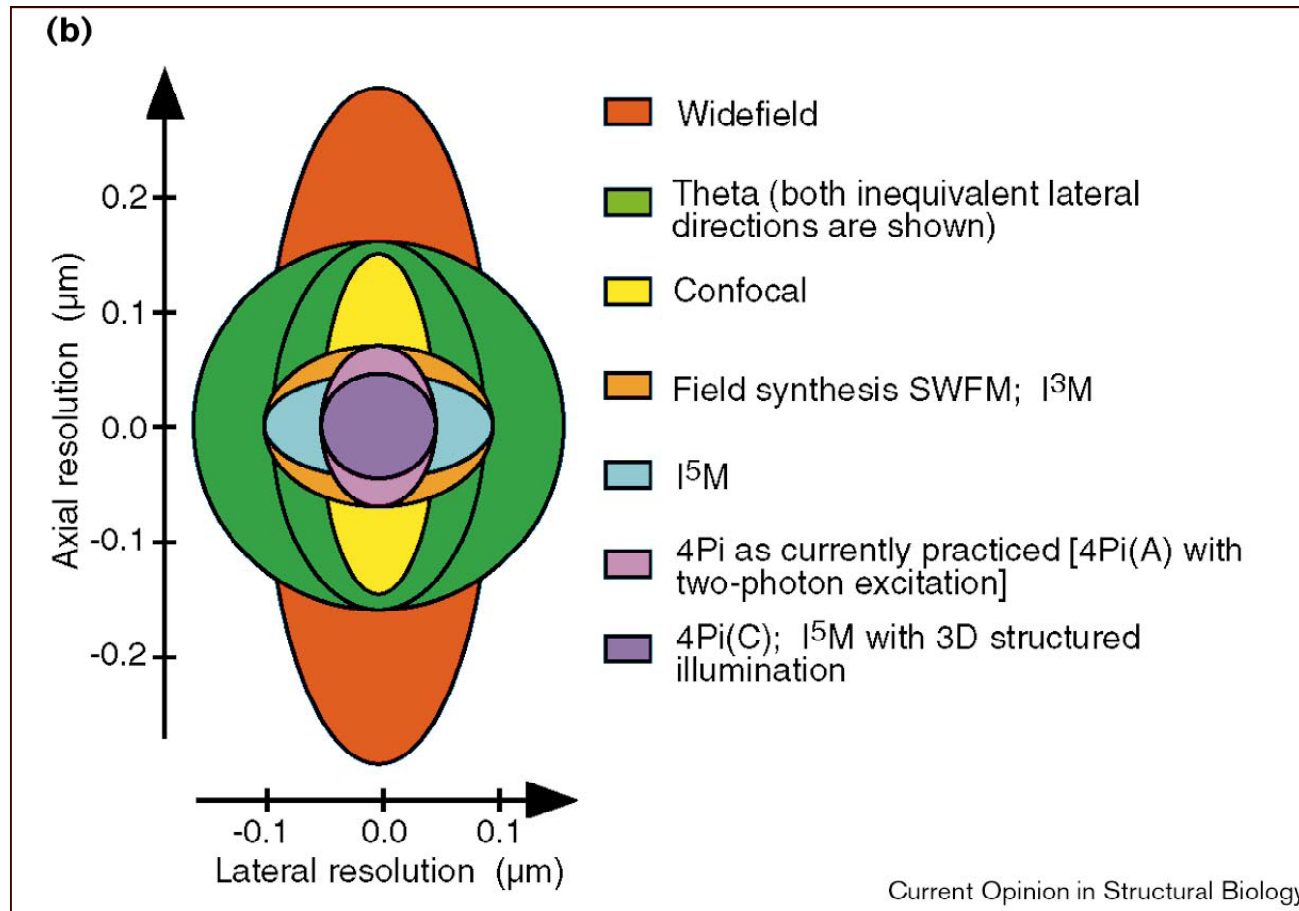

Point spread function is plotted for a wavelength of 550 nm

See for instance review by M.G.L. Gustafsson, Current Opinion in Structural Biology, 9:627, 1999.

Femtosecond Confocal Microscopy

Confocal microscope: Place pinhole in image plane to reject scattered light.

Measure light transmitted through pinhole and scan pinhole throughout microscope's field of view.

Allows imaging through scattering media

fs pulses allow nonlinear (two-photon) excitation of photoactive molecules in sample to be investigated, leading to an increased image contrast.

Curley et al., Optical and Quantum Electron. 24, 851 (1992)

Caution!

Curley et al., not Curly et al.



These Methods Really Do Work!

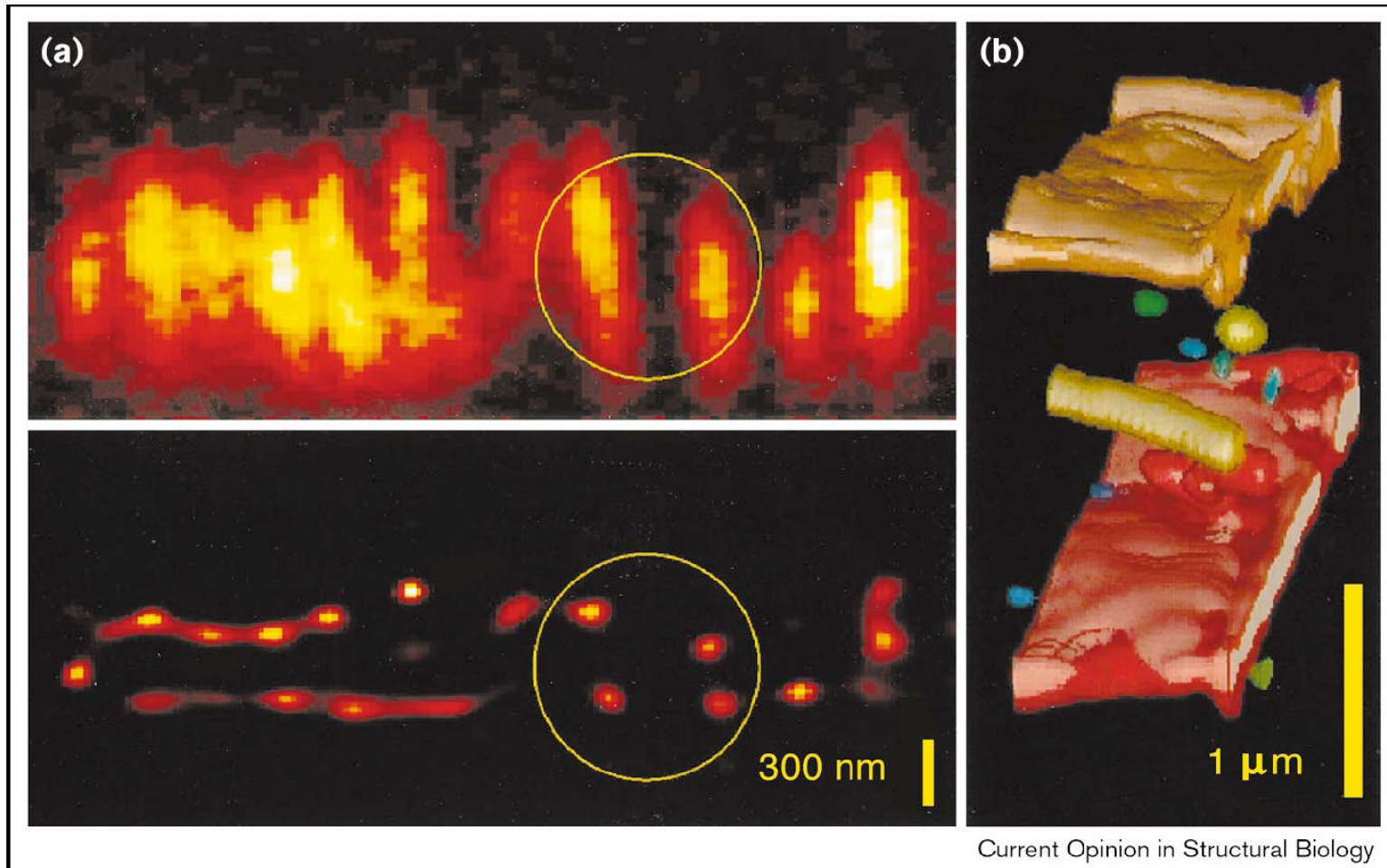

(a) Microtubules in a mouse fibroblast cell. A comparison of single-section side (xz) views of the same area, as seen using conventional confocal microscopy raw data (top) and 4Pi(A) confocal microscopy with two-photon excitation and full deconvolution (bottom). **(b)** 3D reconstruction of actin structures in a fibroblast.

M.G.L. Gustafsson, Current Opinion in Structural Biology, 9:627, 1999.

Multiphoton Excitation Leads to a Reduced Excitation Volume

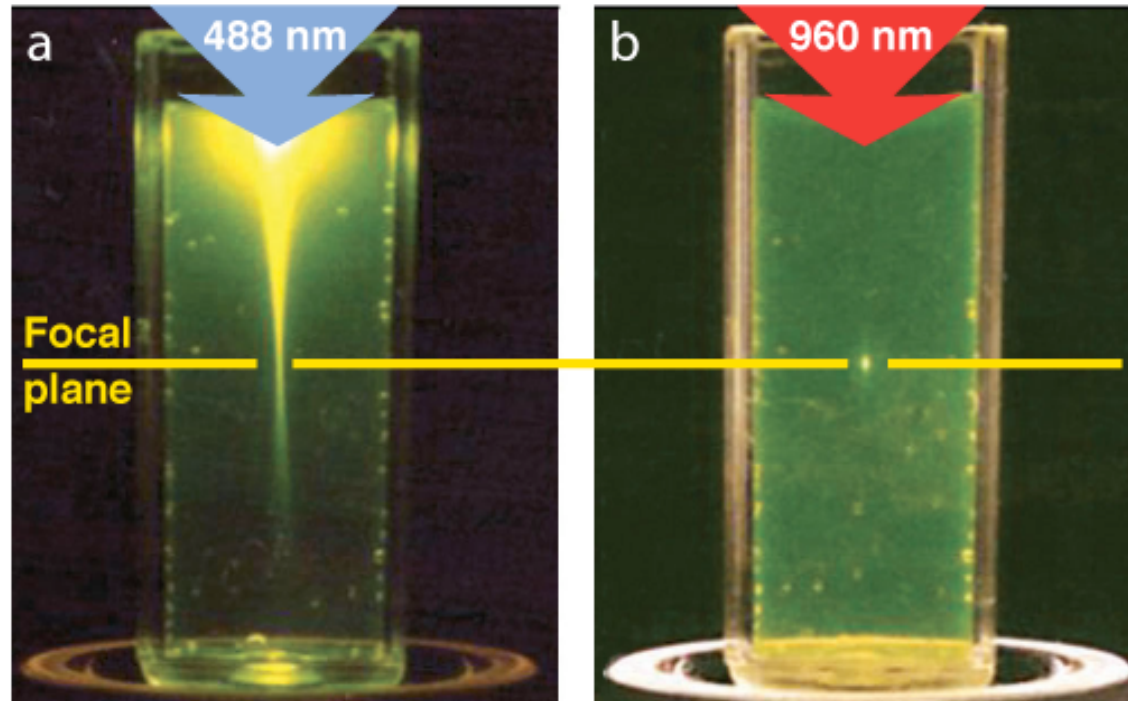

Zipfel, Williams, and Webb, Nature Biotechnology, 21, 1369 (2003).

Structured-Illumination Microscopy

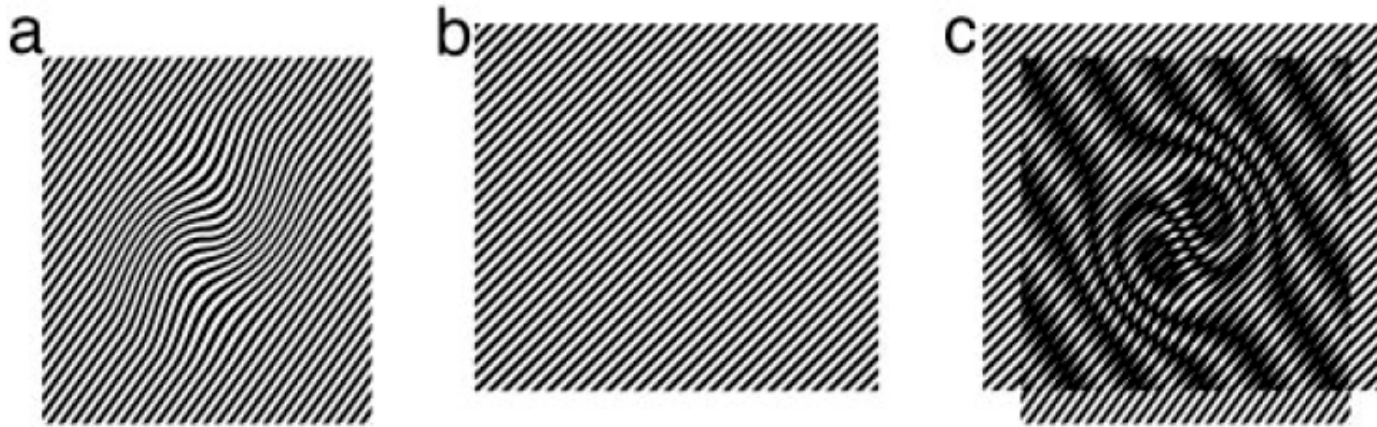

Small-scale features become visible when observed through ruling

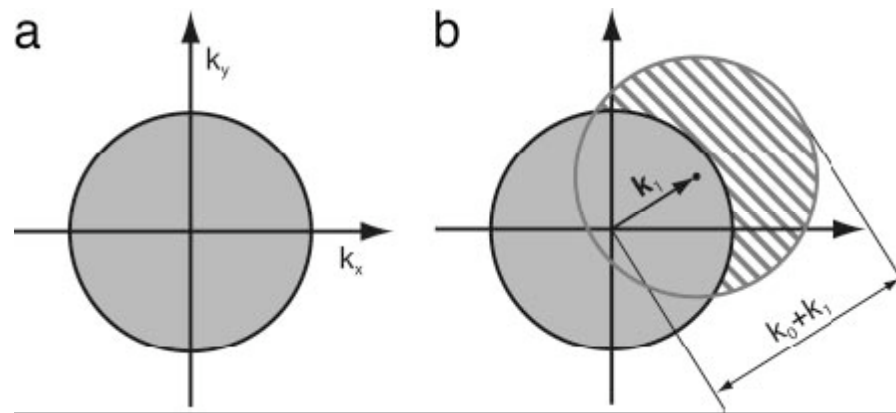

Here is how it works in k-space

M.G.L. Gustafsson, PNAS 102 13081, 2005.

Things Are Even Better in the Nonlinear Case!

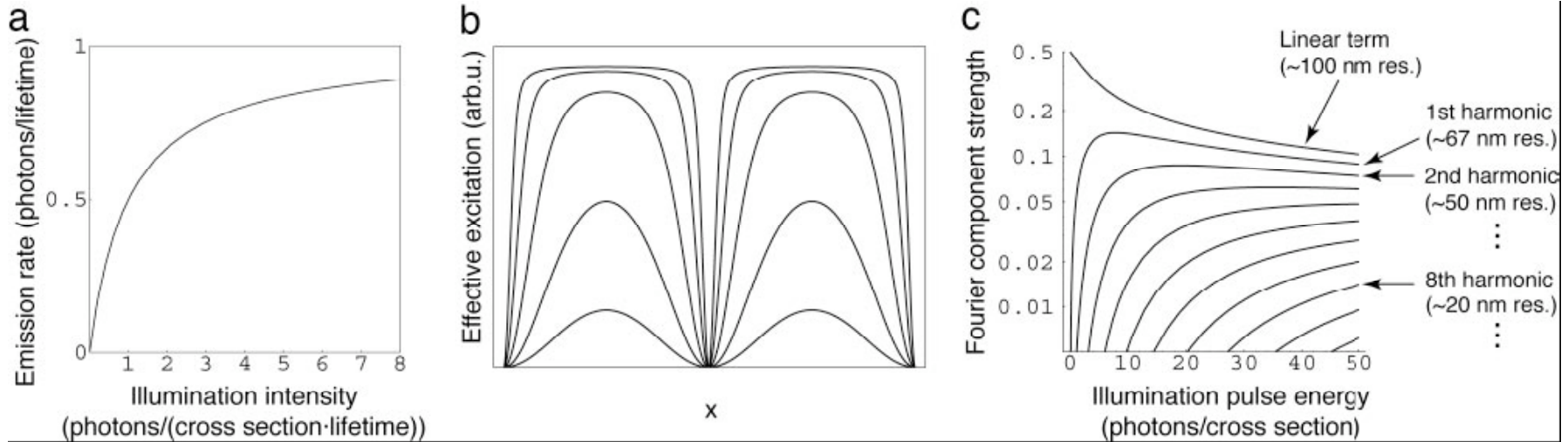

Response of a saturable absorber to a sine-wave intensity modulation

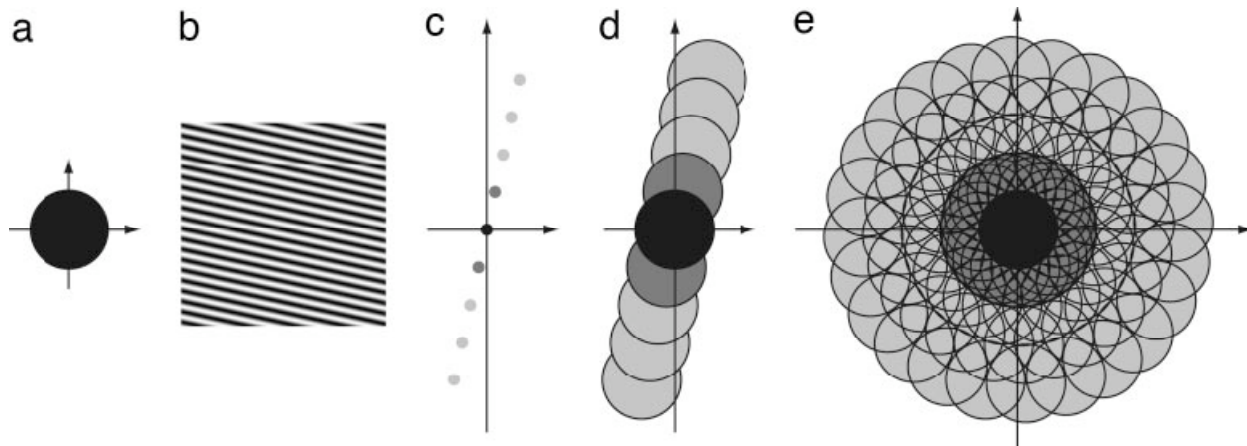

Here is what is happening in k-space

Here Are Some Laboratory Results

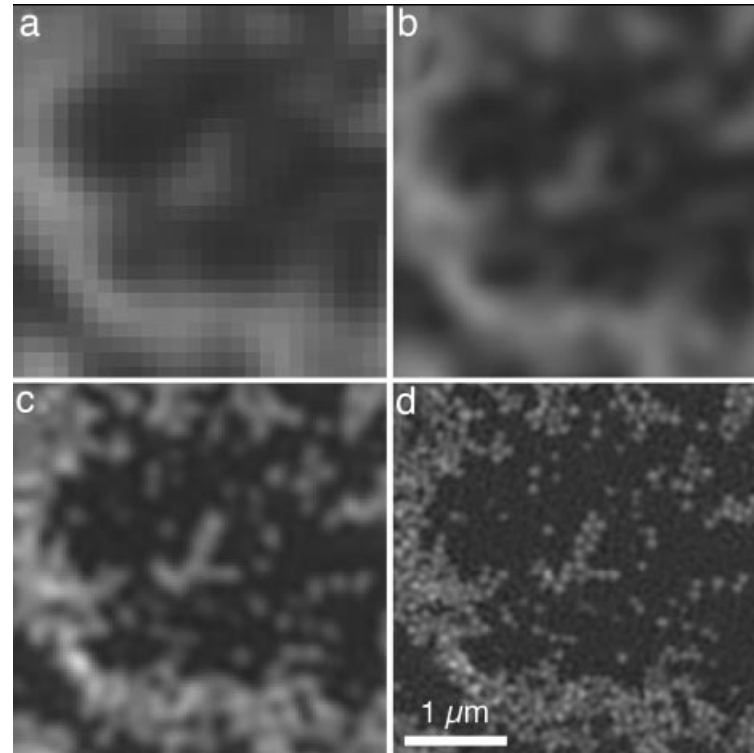

Field of 50-nm fluorescent beads, imaged by (a) conventional microscopy, (b) conventional microscopy plus filtering, (c) linear structured illumination, and (d) saturated structured illumination using illumination pulses with 5.3 mJ cm^{-2} energy density, taking into account three harmonic orders in the processing.

Stimulated Emission Depletion (STED) Microscopy

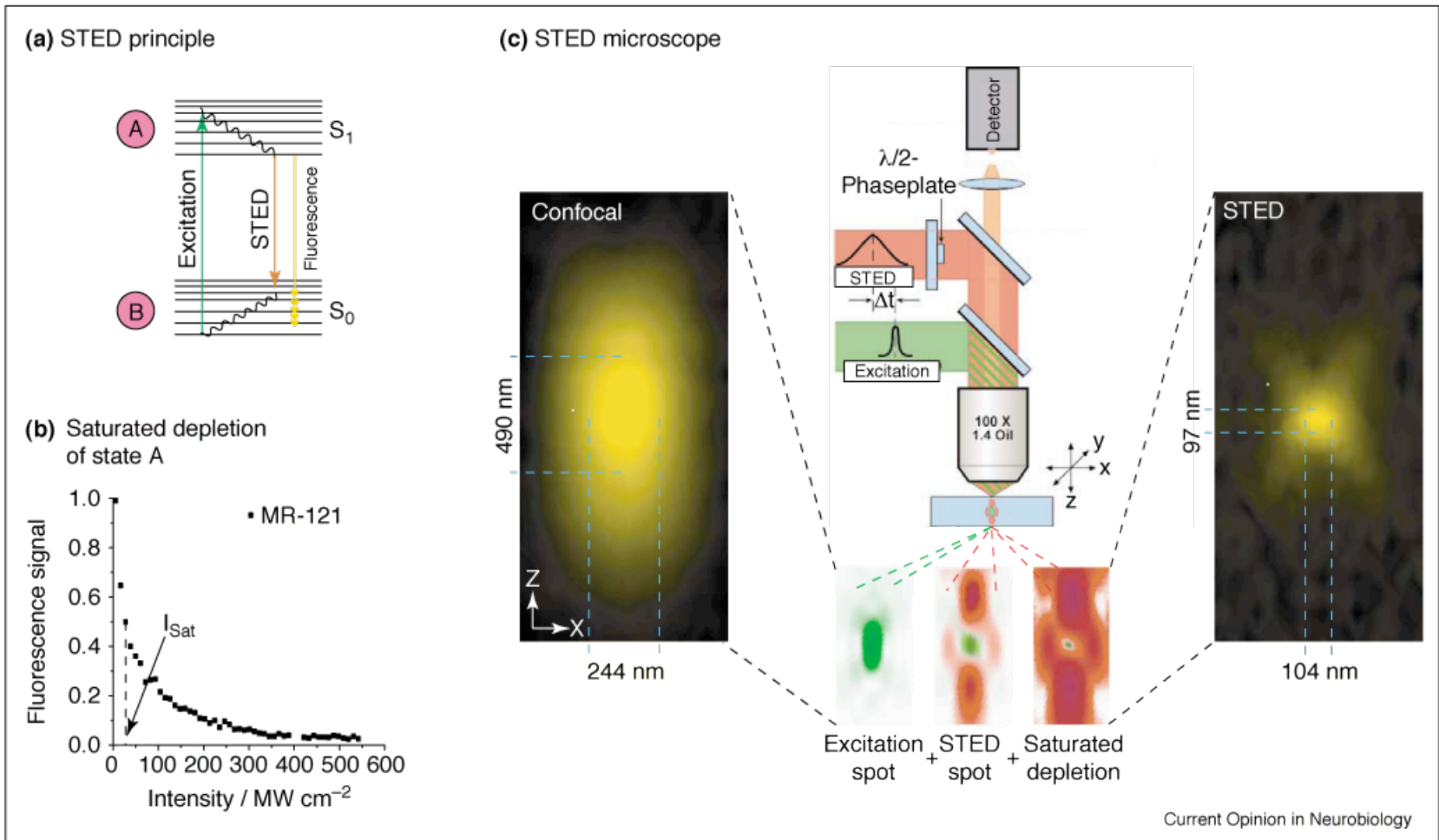

Axial and transverse resolution better than 50 nm.

Hell, Dyba, and Jakobs, Current Opinion in Neurobiology, 14:599, 2004.

Progress in Quantum Lithography

Robert W. Boyd, Sean J. Bentley,
Hye Jeong Chang, and Malcolm N. O'Sullivan-Hale

Institute of Optics, University of Rochester,
Rochester NY, USA

Quantum Lithography

- Entangled photons can be used to form an interference pattern with detail finer than the Rayleigh limit
- Process “in reverse” performs sub-Rayleigh microscopy, etc.
- Resolution $\approx \lambda / 2N$, where N = number of entangled photons

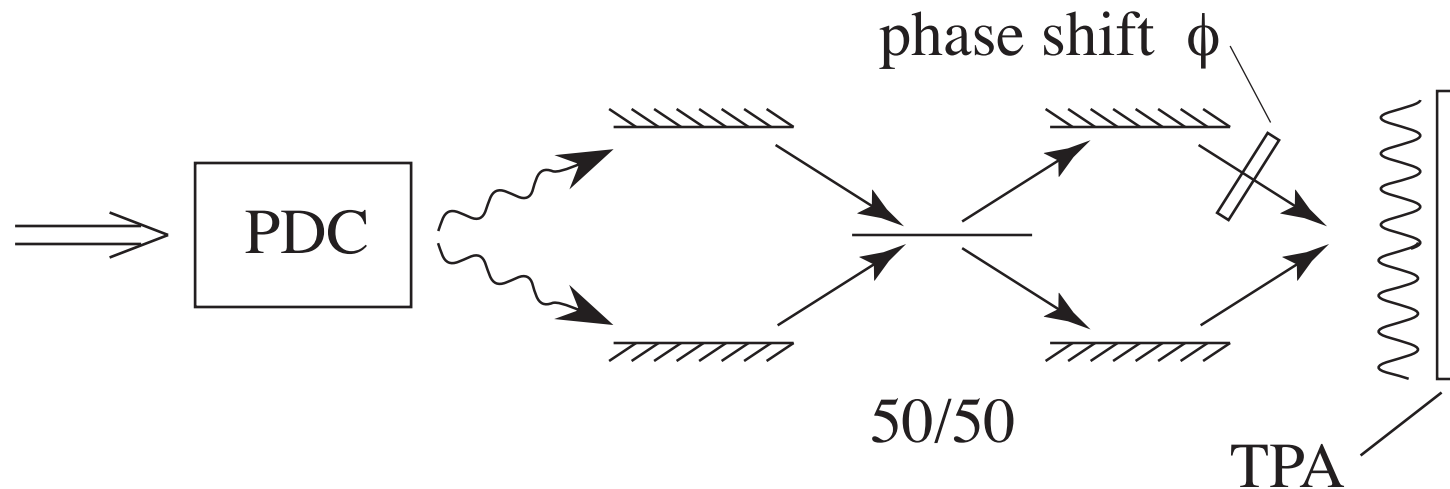

Boto et al., Phys. Rev. Lett. 85, 2733, 2000.

("al." includes Jon Dowling)

Quantum Lithography: Easier Said Than Done

- Need an N -photon recording material

For proof-of-principle studies, can use N -th-harmonic generator, correlation circuitry, N -photon photodetector.

For actual implementation, use ????

Maybe best bet is UV lithographic material excited in the visible or a broad bandgap material such as PMMA excited by multiphoton absorption.

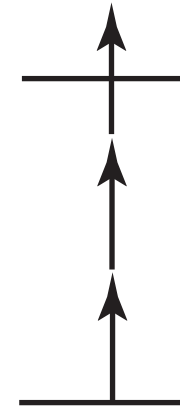

3PA in PMMA
breaks chemical
bond, modifying
optical properties.
Problem: self
healing

- Need an intense source of individual biphotons (Inconsistency?)

Maybe a high-gain OPA provides the best tradeoff between high intensity and required quantum statistics

Use of High-Gain Parametric Amplifier

Is two-photon interference pattern preserved?

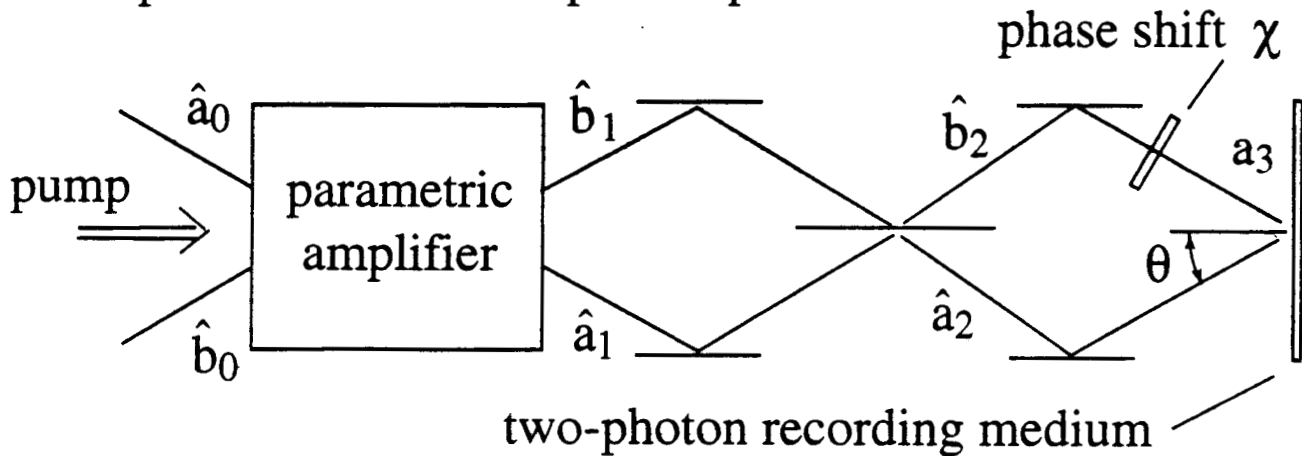

- Transfer equations of OPA

$$\text{where } \hat{a}_1 = U\hat{a}_0 + V\hat{b}_0^\dagger, \quad \hat{b}_1 = U\hat{b}_0 + V\hat{a}_0^\dagger$$

$$U = \cosh G \quad V = -i \exp(i\varphi) \sinh G$$

- Field at recording medium

$$\hat{a}_3 = \frac{1}{\sqrt{2}} \left[(-e^{i\chi} + i)(U\hat{a}_0 + V\hat{b}_0^\dagger) + (ie^{i\chi} - 1)(U\hat{b}_0 + V\hat{a}_0^\dagger) \right]$$

- Two-photon absorption probability

$$\langle 0, 0 | \hat{a}_3^\dagger \hat{a}_3^\dagger \hat{a}_3 \hat{a}_3 | 0, 0 \rangle = 4|V|^2 \left[|U|^2 \cos^2 \chi + 2|V|^2 \right]$$

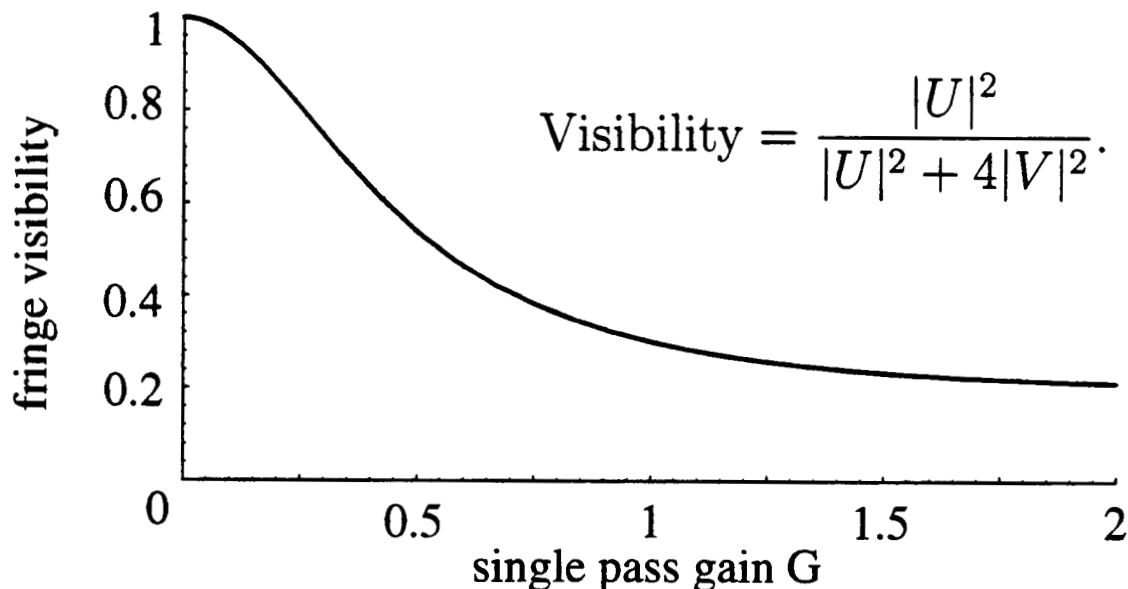

QUANTUM LITHOGRAPHY RESEARCH

Experimental Layout

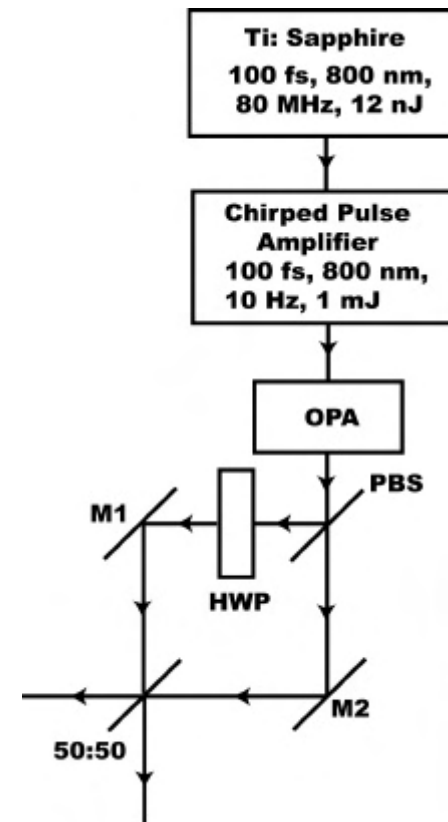
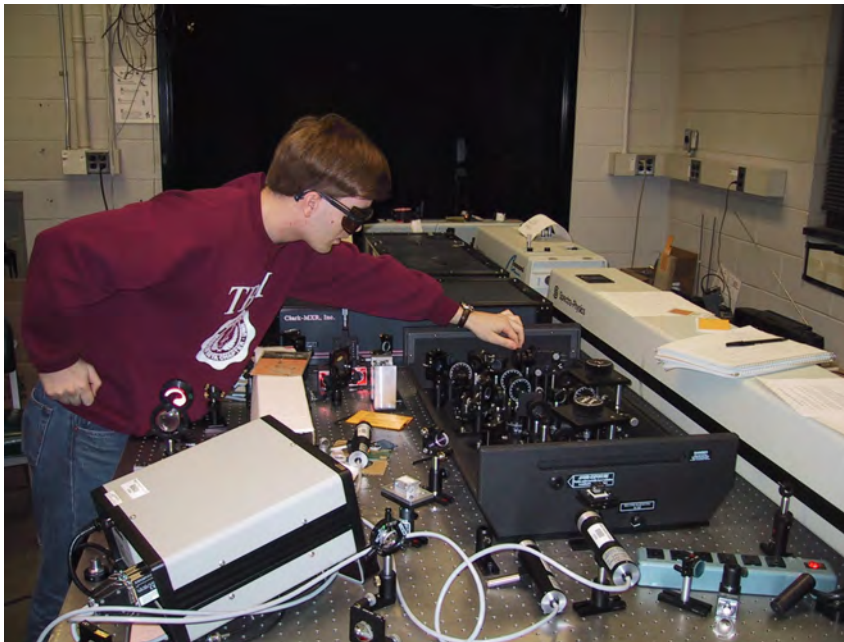

Non-Quantum Quantum Lithography

Concept: average M shots with the phase of shot k given by $2\pi k/M$

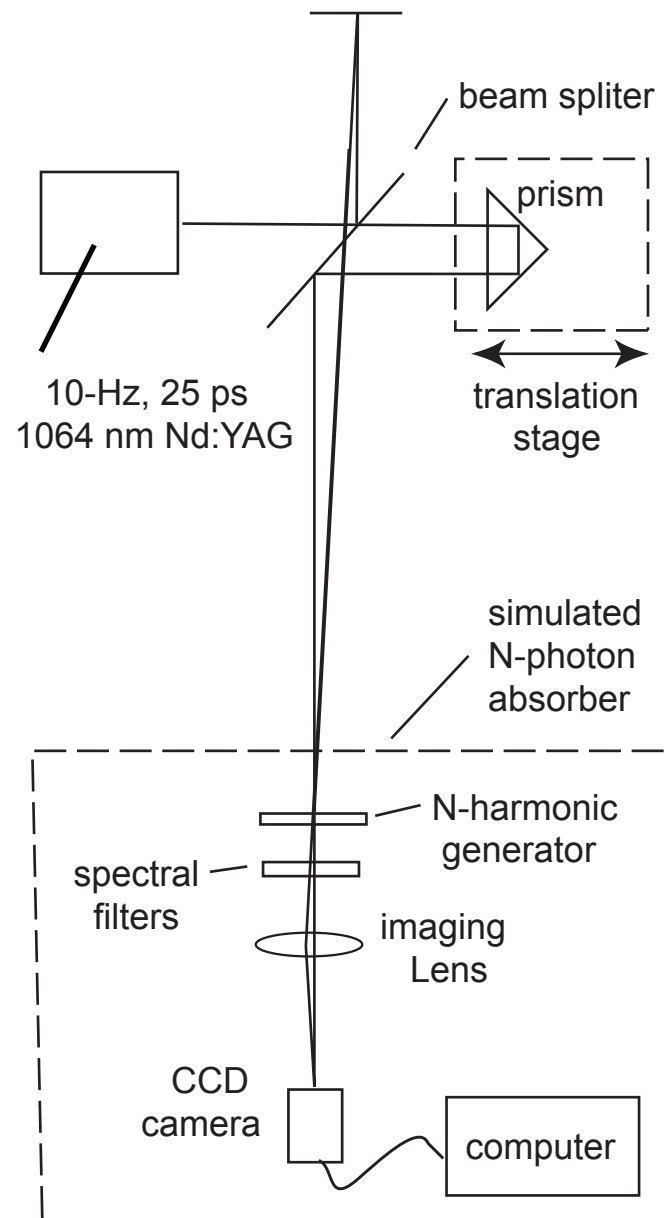
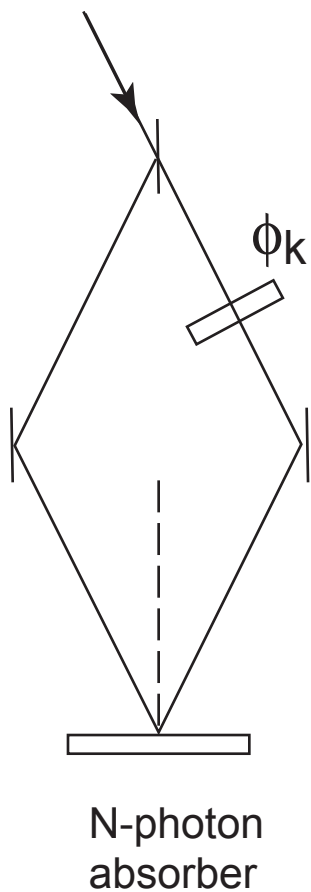

$N=1, M=1$

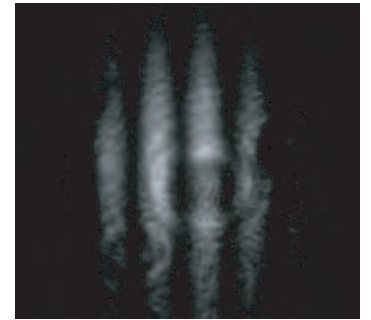

$N=2, M=1$

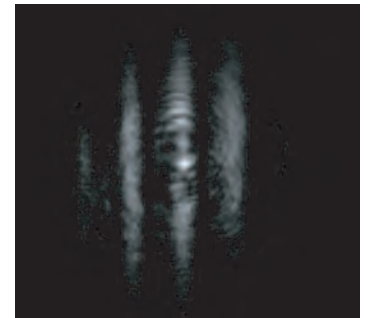

$N=2, M=2$

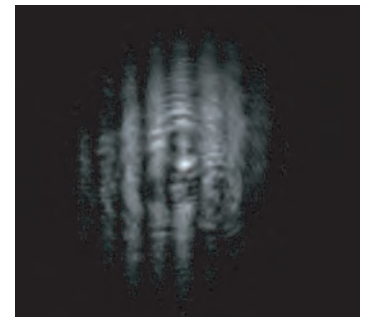

Spatial Resolution of Various Systems

- **Linear optical medium**

$$E = 1 + \cos kx$$

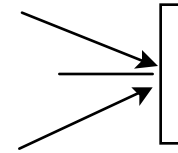

- **Two-photon absorbing medium, classical light**

$$\begin{aligned} E &= (1 + \cos kx)^2 = 1 + 2 \cos kx + \cos^2 kx \\ &= 3/2 + 2 \cos kx + (1/2) \cos 2kx \end{aligned}$$

- **Two-photon absorbing medium, entangled photons**

$$E = 1 + \cos 2kx$$

where $k = 2(\pi/\lambda) \sin \theta$

Demonstration of Fringes Written into PMMA

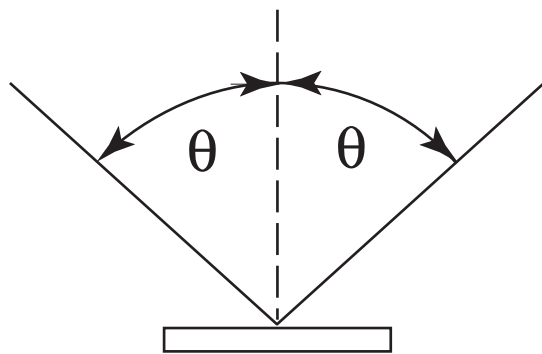

N-photon absorber
(N = 3 ?)

$\theta = 70$ degrees
write wavelength = 800 nm
pulse energy = 130 μ J per beam
pulse duration = 120 fs
period = $\lambda / (2 \sin \theta) = 425$ nm

PMMA on glass substrate
develop for 10 sec in MBIK
rinse 30 sec in deionized water



AFM

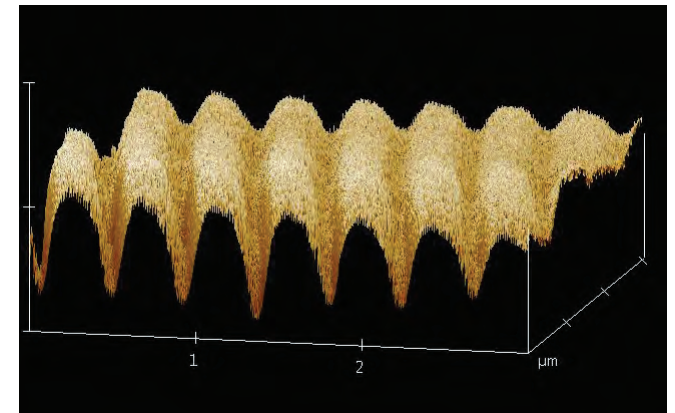
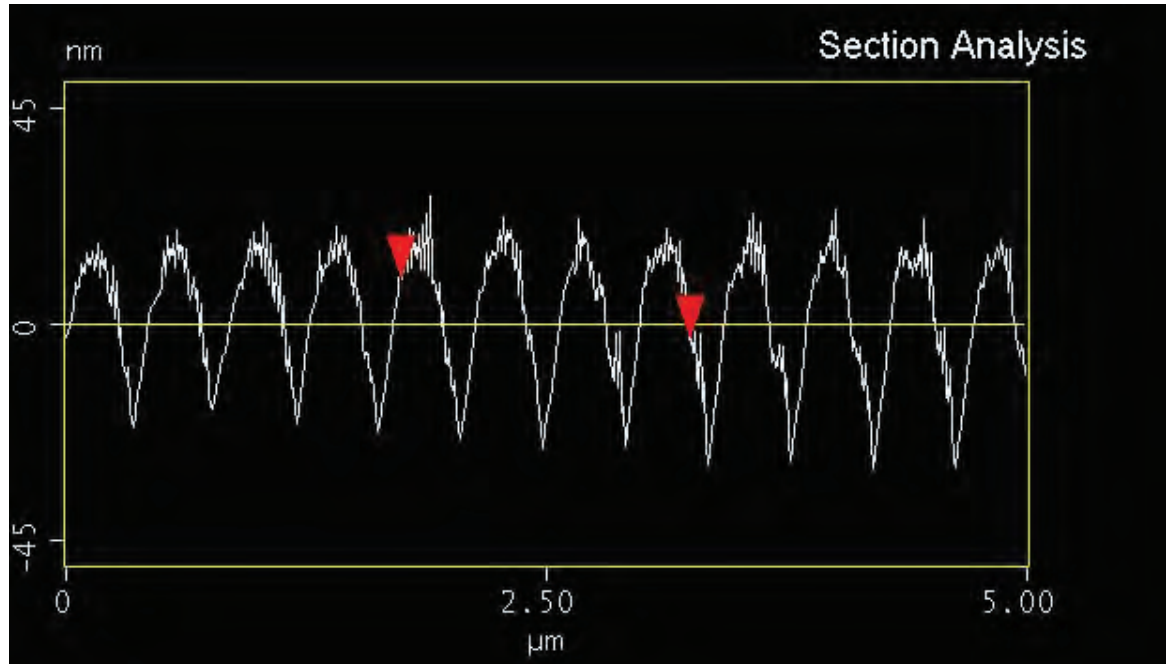

PMMA is a standard lithographic material

Demonstration of Sub-Rayleigh Fringes (Period = $\lambda/4$)

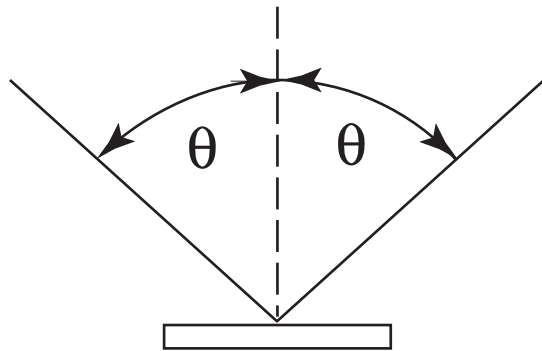

N-photon absorber

$\theta = 70$ degrees

two pulses with 180 deg phase shift

write wavelength = 800 nm

pulse energy = 90 μ J per beam

fundamental period = $\lambda / (2 \sin \theta) = 425$ nm

period of written grating = 212 nm

PMMA on glass substrate

develop for 10 sec in MBIK

rinse 30 sec in deionized water

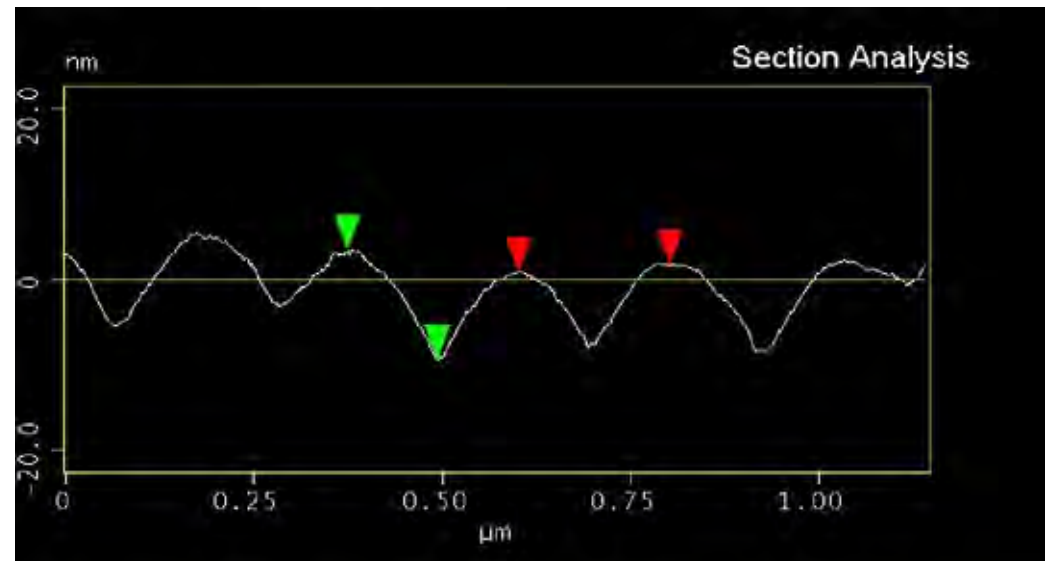
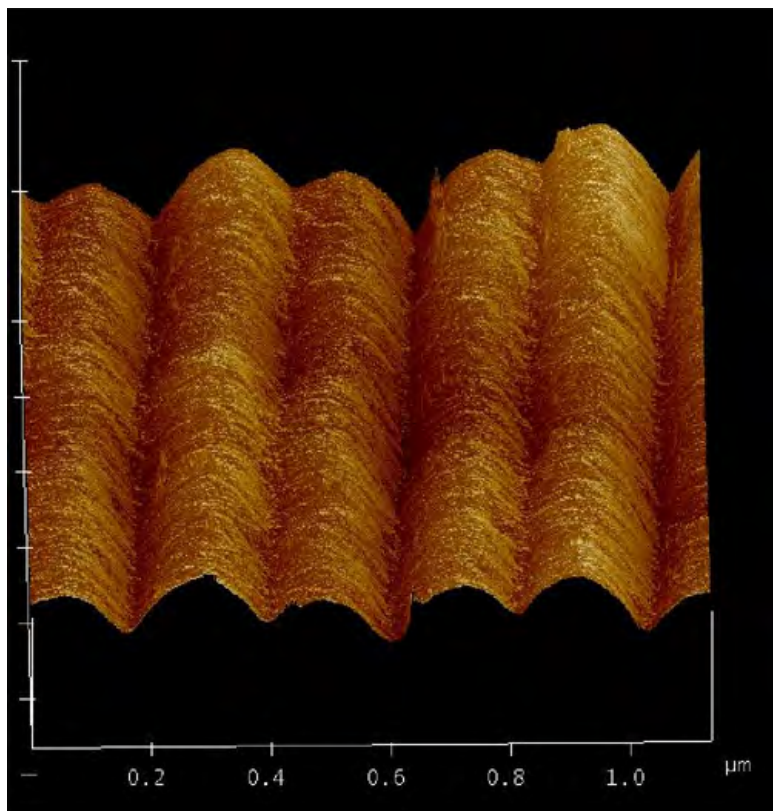

Significance of PMMA Grating Results

- Provides an actual demonstration of sub-Rayleigh resolution by the phase-shifted grating method
- Demonstrates an N-photon absorber with adequate resolution to be of use in true quantum lithography

Quantum Lithography Prospects

Quantum lithography (as initially proposed by Dowling) has a good chance of becoming a reality.

Classically simulated quantum lithography may be a realistic alternative approach, and one that is much more readily implemented.

Progress in Ghost Imaging

Robert W. Boyd, Ryan S. Bennink, Sean J. Bentley,
Irfan Ali Khan and John C. Howell

Institute of Optics and
Department of Physics and Astronomy,
University of Rochester, Rochester NY, USA

Ghost (Coincidence) Imaging

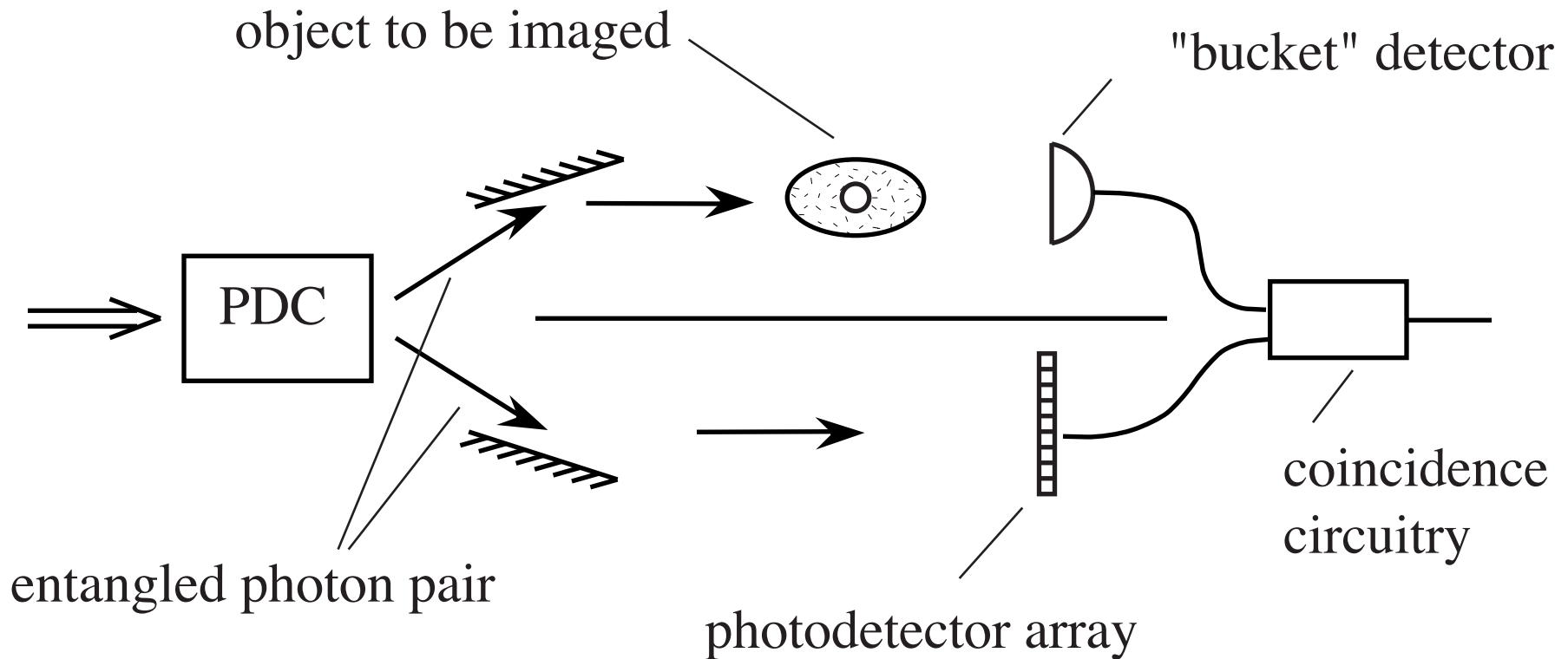

- Obvious applicability to remote sensing!
- Is this a purely quantum mechanical process?

Strekalov et al., Phys. Rev. Lett. 74, 3600 (1995).

Pittman et al., Phys. Rev. A 52 R3429 (1995).

Abouraddy et al., Phys. Rev. Lett. 87, 123602 (2001).

Bennink, Bentley, and Boyd, Phys. Rev. Lett. 89 113601 (2002).

Bennink, Bentley, Boyd, and Howell, PRL 92 033601 (2004)

Gatti, Brambilla, and Lugiato, PRL 90 133603 (2003)

Gatti, Brambilla, Bache, and Lugiato, PRL 93 093602 (2003)

Classical Coincidence Imaging

We have performed coincidence imaging with a demonstrably classical source.

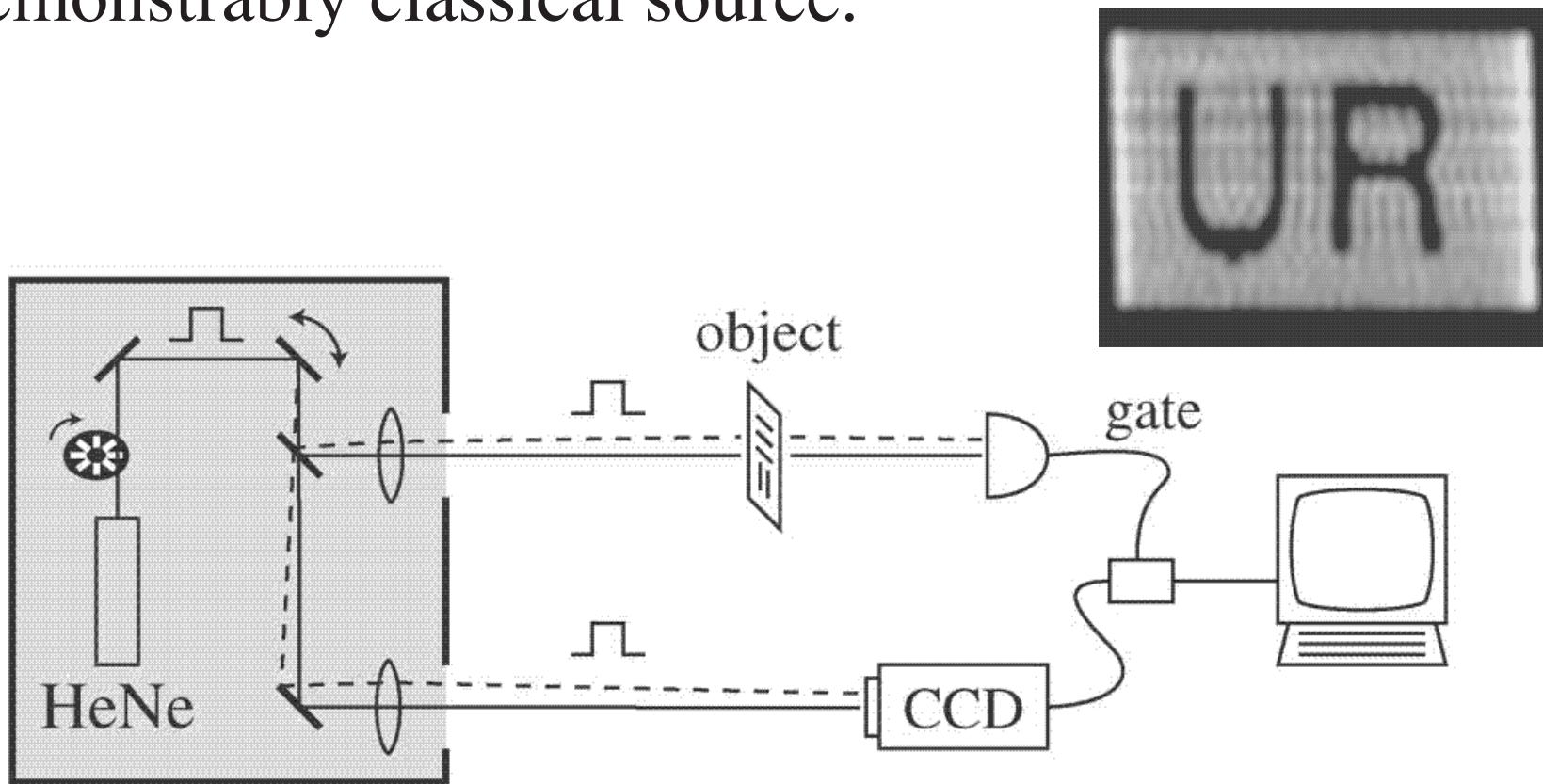

Bennink, Bentley, and Boyd, Phys. Rev. Lett. **89** 113601 (2002).

Ghost Diffraction with a Classically Correlated Source

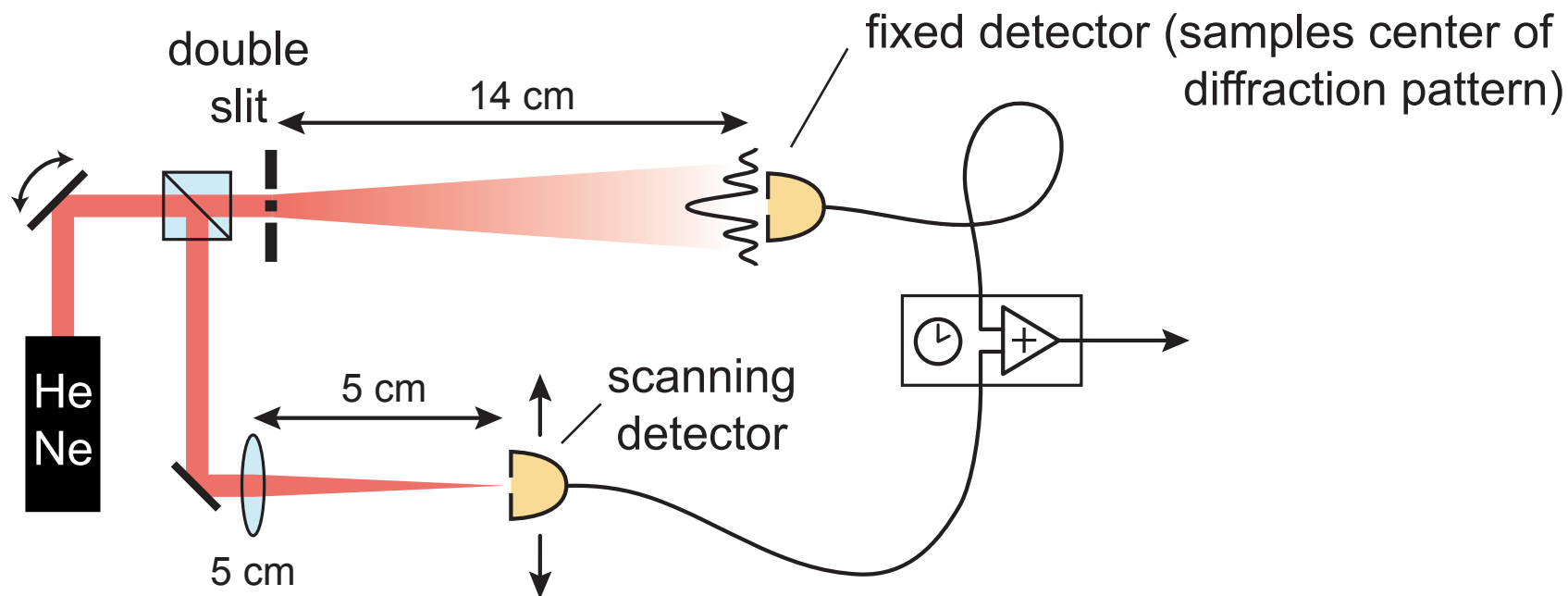

Even diffraction effects are observable with classical coincidence imaging.

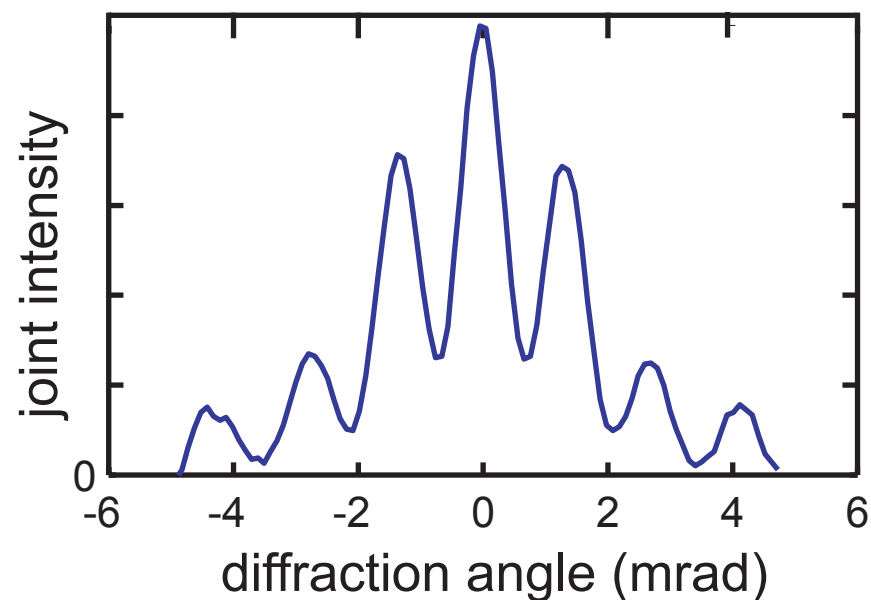

Further Development

VOLUME 90, NUMBER 13

PHYSICAL REVIEW LETTERS

week ending
4 APRIL 2003

Entangled Imaging and Wave-Particle Duality: From the Microscopic to the Macroscopic Realm

A. Gatti, E. Brambilla, and L. A. Lugiato

INFN, Dipartimento di Scienze CC.FF.MM., Università dell'Insubria, Via Valleggio 11, 22100 Como, Italy

(Received 11 October 2002; published 3 April 2003)

We formulate a theory for ~~entangled~~ entangled imaging, which includes also the case of a large number of photons in the two entangled beams. We show that the results for imaging and for the wave-particle duality features, which have been demonstrated in the microscopic case, persist in the macroscopic domain. **We show that the quantum character of the imaging phenomena is guaranteed by the simultaneous spatial entanglement in the near and in the far field.**

DOI: 10.1103/PhysRevLett.90.133603

PACS numbers: 42.50.Dv, 03.65.Ud

Near- and Far-Field Imaging Using Quantum Entanglement

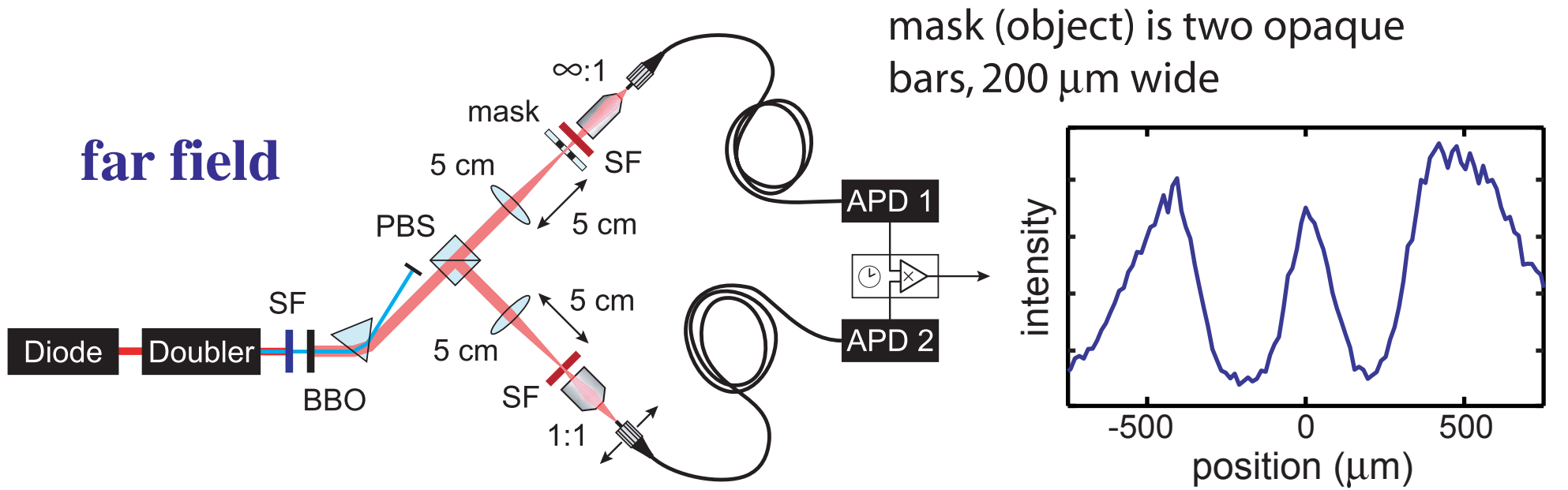
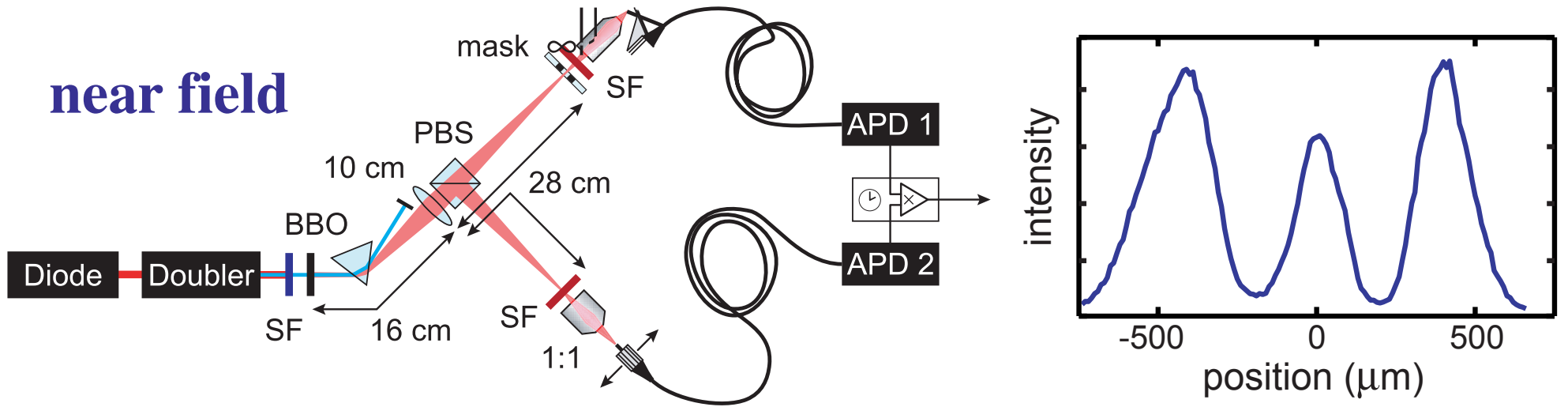

Good imaging observed in both the near and far fields!

Near- and Far-Field Imaging With a Classical Source

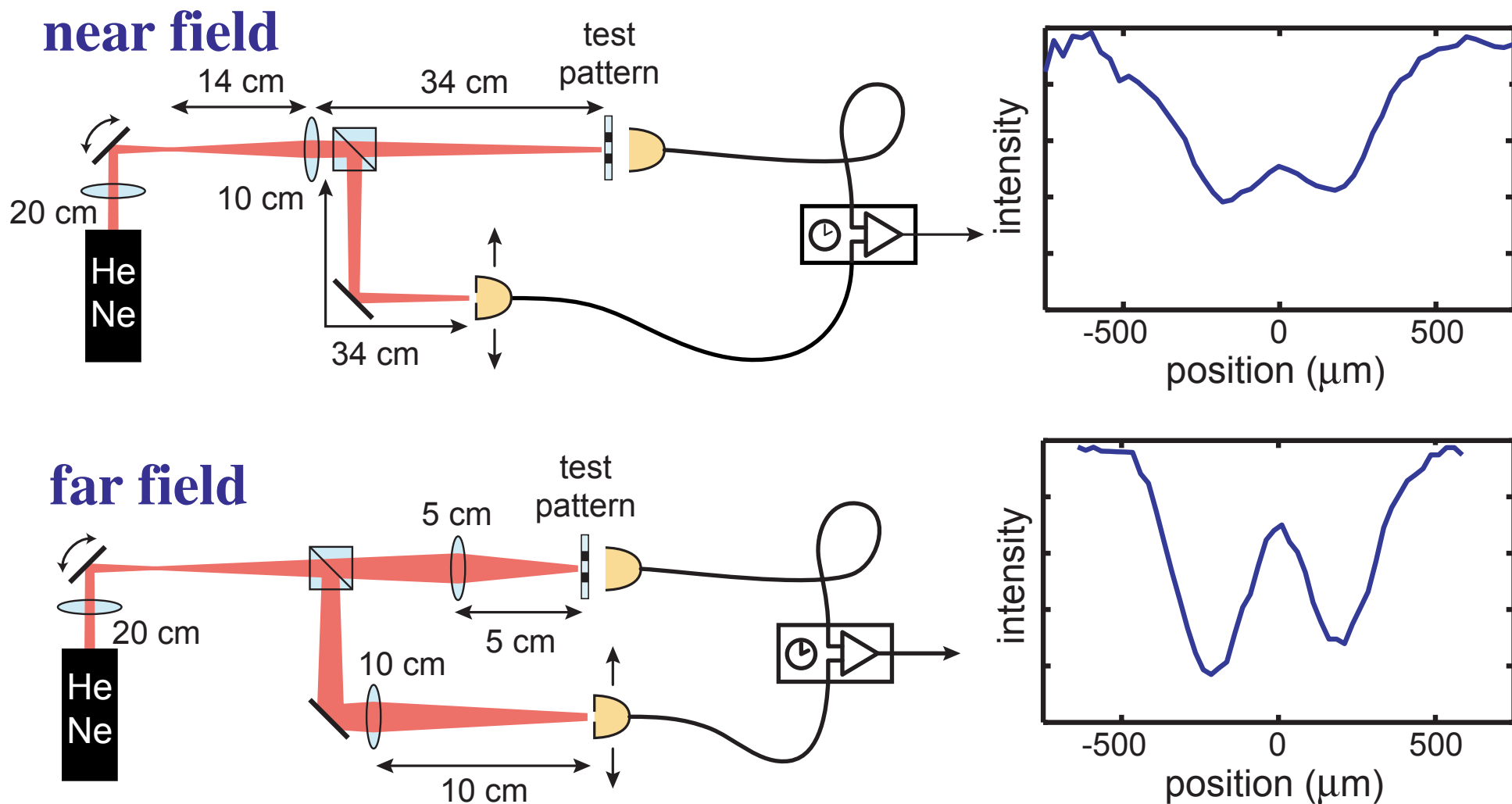

- Good imaging can be obtained only in near field **or** far field.
- Detailed analysis shows that in the quantum case the space-bandwidth exceeded the classical limit by a factor of ten.

Is Entanglement Really Needed for Ghost Imaging with an Arbitrary Object Location?

Gatti et al. (PRA and PRL, 2004) argue that thermal sources can mimic the quantum correlations produced by parametric down conversion. (Related to Brown-Twiss effect.)

Experimental confirmation of ghost imaging with thermal sources presented by Como and UMBC groups

But the contrast of the images formed in this manner is limited to $1/2$ or $1/N$ (depending on the circumstances) where N is the total number of pixels in the image.

The EPR Paradox

In 1935, Einstein, Podolsky, and Rosen argued that quantum mechanics must be "incomplete."

entangled particles, perfectly
correlated in position & momentum

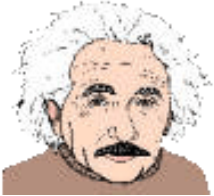

measure x or p

Det. 1



Det. 2

- measure $x_1 \Rightarrow$ know x_2 with certainty ($\Delta x_2 = 0$)
 - measure $p_1 \Rightarrow$ know p_2 with certainty ($\Delta p_2 = 0$)
 - measurement of particle 1 cannot affect particle 2 (?!)
- $\Rightarrow \Delta x_2 = 0$ and $\Delta p_2 = 0$ simultaneously (?!)

in conflict with $\Delta x_2 \Delta p_2 \geq \frac{1}{2} \hbar$

Quantum Imaging and the EPR Effect

- The quantum signature of ghost imaging is simultaneous correlations in both x and k
- EPR thought that simultaneous correlations in both x and p contradicted Heisenberg's uncertainty principle

The criterion for quantum features in coincidence imaging,

$$\left((\Delta x_2)_{x_1} \right)^2 \left((\Delta k_2)_{k_1} \right)^2 \leq 1$$

is equivalent to that for violating the EPR hypothesis.

- With entangled photons, one can perform the original EPR experiment (not Bell's). EPR were considering continuous variables (momentum and position) not the spin variable.

Position-Momentum Realization of the EPR Paradox

position (near field)

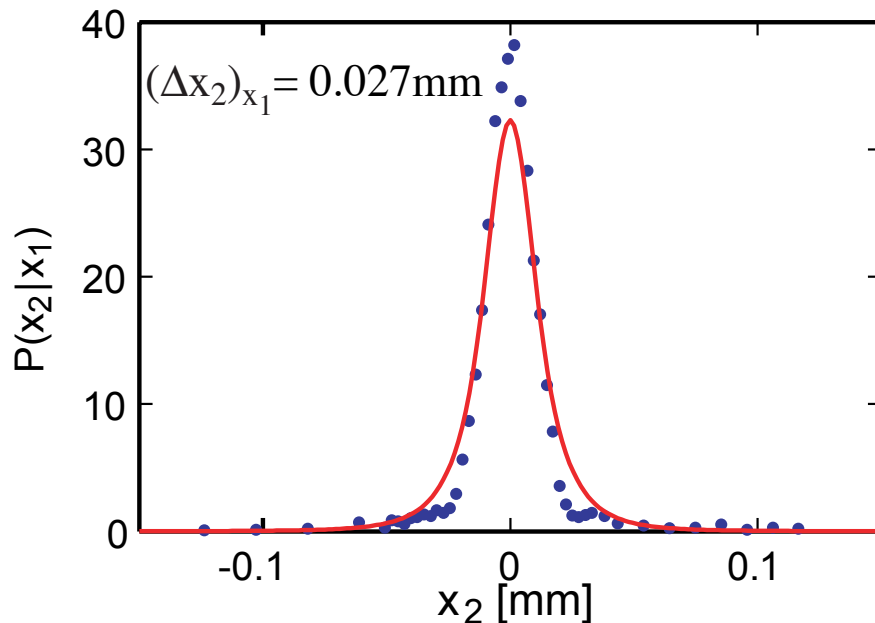
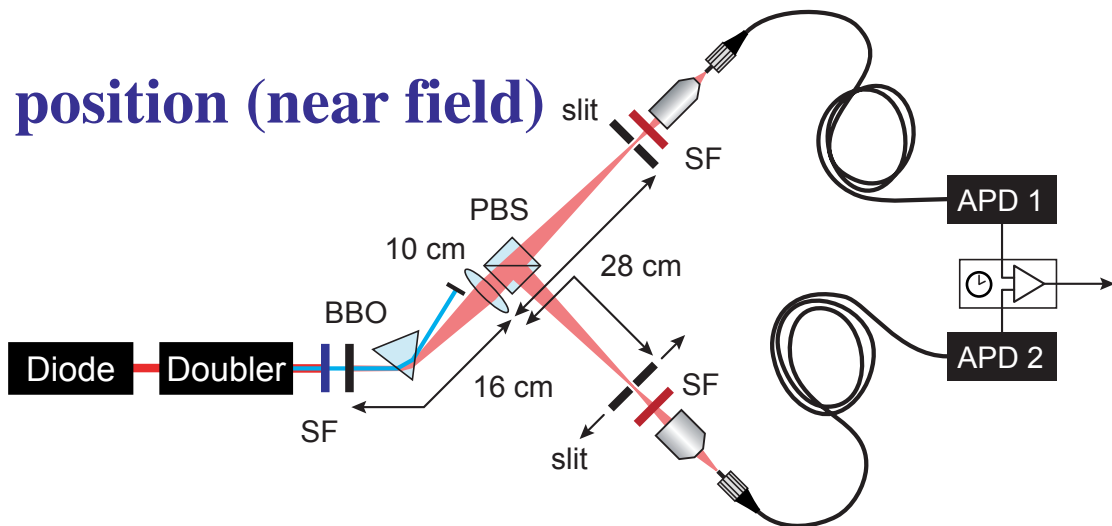

transverse momentum
(far field)

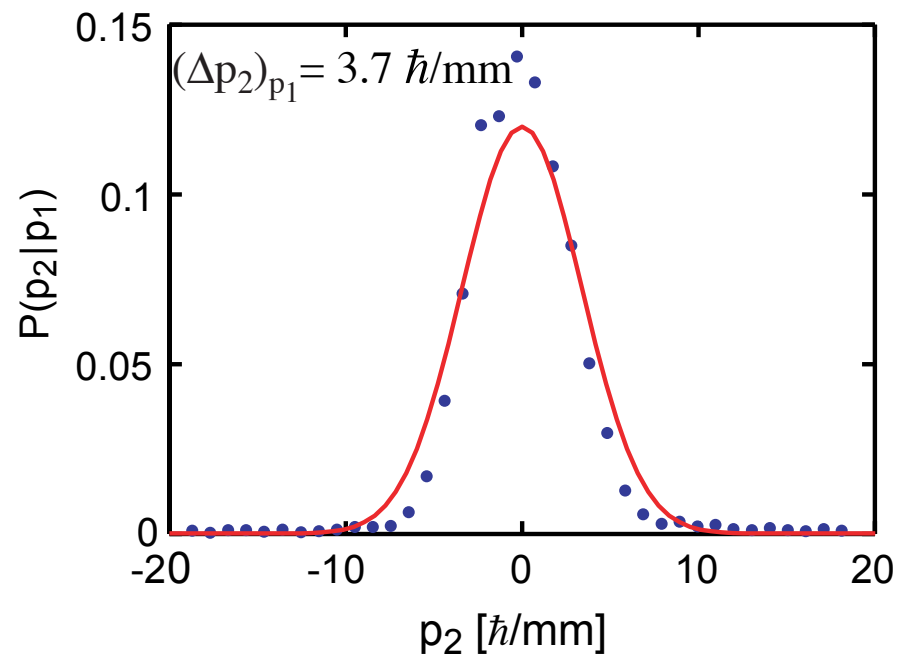
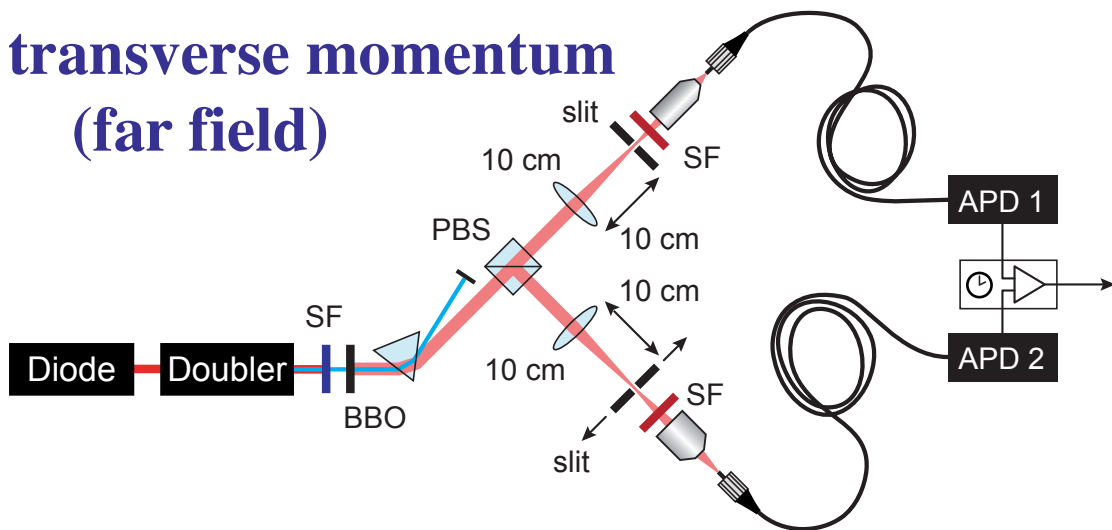

- We find that $(\Delta x_2)_{x_1} (\Delta p_2)_{p_1} = 0.1 \hbar$

Discussion: Position-Momentum Realization of the EPR Paradox

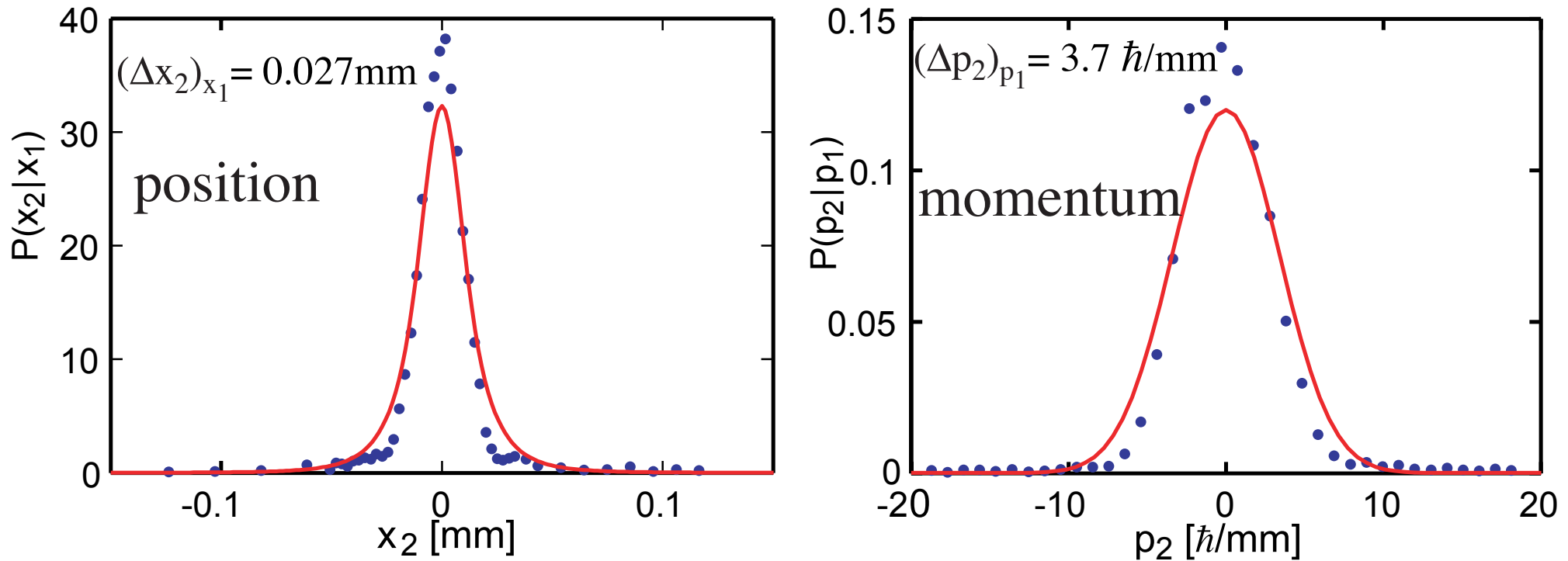

- The spread in p is determined by the momentum uncertainty of the pump beam, which is limited by the pump spot size.
- The spread in x is determined by the angular bandwidth of the PDC process, which is limited by phase matching requirements.
- We find that $(\Delta x_2)_{x_1}^2 (\Delta p_2)_{p_1}^2 = 0.01 \hbar^2$, where according to EPR the product could be no smaller than unity.
- PRL, 92, 210403 (2004).

EPR Entanglement: previous work

- Squeezed light fields (quadrature squeezed correlations)
 - Reid and Drummond, PRL 60, 2731 (1988)
 - Ou et al, PRL 68, 3663 (1992)
 - Silberhorn et al, PRL 86, 4267 (2001)
 - Bowen et al, PRL 89, 253601 (2002)
- Collective atomic spin variables (spin observables)
 - Julsgaard, Nature 413, 400 (2001)
- Modern rephrasing of continuous entanglement
 - Duan et al, PRL 84, 2722 (2000)
 - Simon, PRL 84, 2726 (2000)
 - Mancini et al, PRL 88, 120401 (2002)

Pixel Entanglement: Entanglement In A Very Large Hilbert Space

Quantum pixel: discrete average of a non-commuting, continuous variable (e.g., x or p).

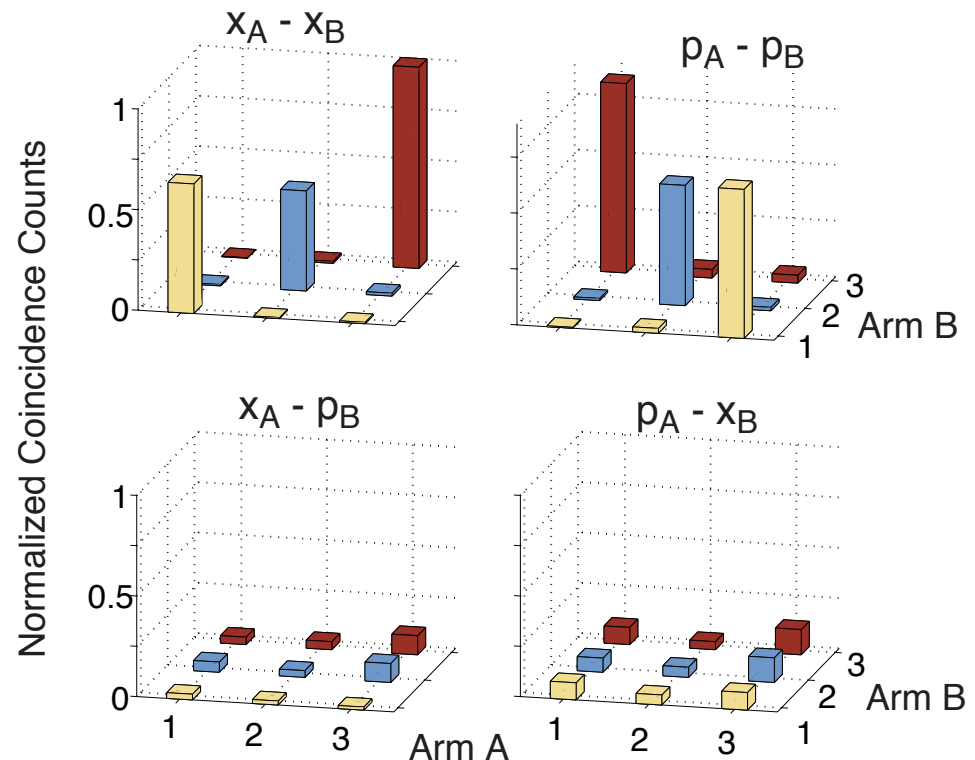
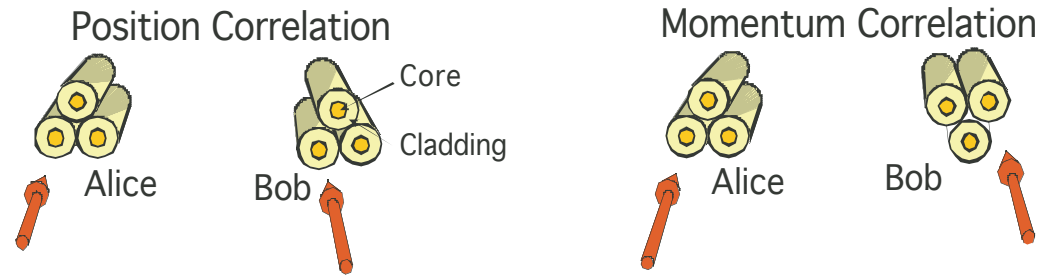
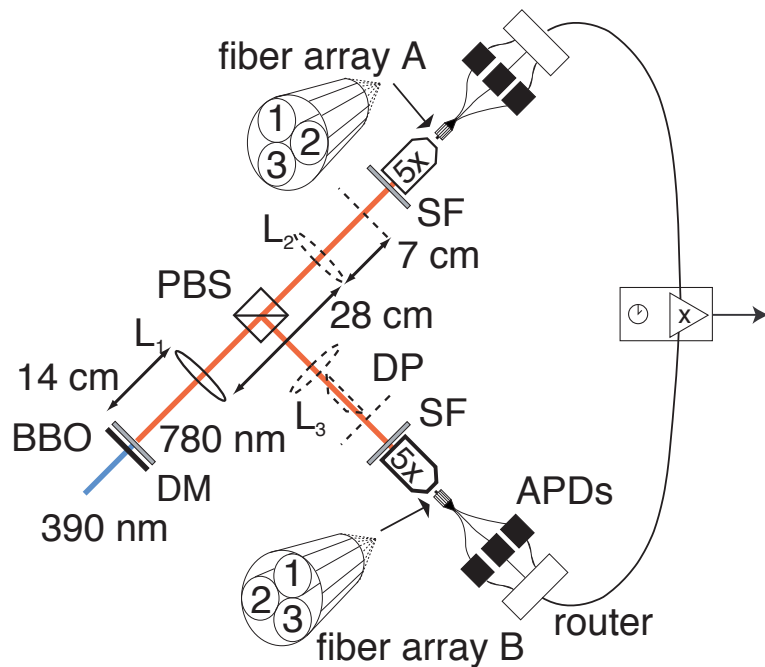

Possible application: generalization of cryptographic protocols to qudits of higher dimension d .

Summary

Quantum lithography has a good chance of becoming a reality.

The quantum vs. classical nature of ghost imaging is more subtle than most of us had appreciated.

Many of our cherished “quantum effects” can be mimicked classically.

There is still work to be done in the context of quantum imaging to delineate the quantum/classical frontier.

Special Thanks to My Students and Research Associates

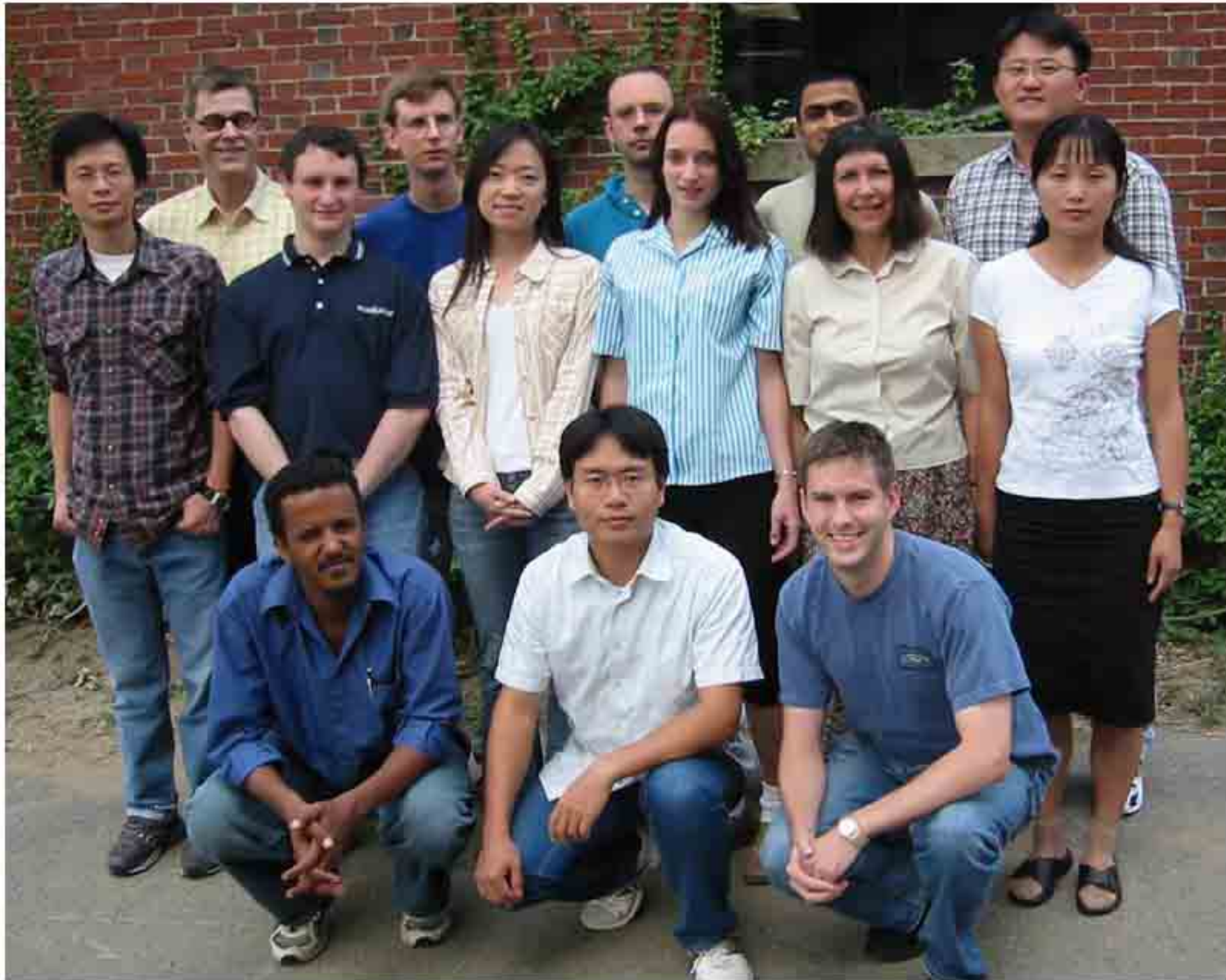

Thank you for your attention!



Thank you for your attention!

Our results are posted on the web at:

<http://www.optics.rochester.edu/~boyd>

Research in Quantum Imaging

Quantum Imaging or Quantum Imogene?



Major US Initiative in Quantum Imaging

Quantum Imaging MURI Team

Robert Boyd, John Howell, UR

Sasha Sergienko, Bahaa Saleh, Mal Teich, BU

Jon Dowling, LSU

Jeff Shapiro, MIT

Geraldo Barbosa, Prem Kumar, NWU

Yanhua Shih, Fow-Sen Choa, Morton Rubin, UMBC

International Collaborators

Claude Fabre, University of Paris

Mikhail Kolobov, University of Lille

Luigi Lugiato, Alessandra Gatti, Como

Quantum Imaging Research Plan

Quantum Imaging Systems

Quantum Optical Coherence Tomography (QOCT).

Quantum Coincidence (or Ghost) Imaging.

Quantum Laser Radar.

Quantum Lithography.

Quantum Imaging Technologies

Intense Sources of Entangled Photons

Parametric Downconversion in Periodically Poled Waveguides.

Quantum Entangled Sources based on Third-Order Interactions.

Entanglement Utilizing Complex Pump Mode Patterns.

High-Order Entanglement.

Pixel Entanglement and Secure Transmission of Images.

Unified Theoretical Framework for Classical and Quantum Imaging.

Quantum Imaging Research Plan

Quantum Imaging Systems

Quantum Optical Coherence Tomography (QOCT).

Quantum Coincidence (or Ghost) Imaging.

Quantum Laser Radar.

Quantum Lithography.

Quantum Imaging Technologies

Intense Sources of Entangled Photons

Parametric Downconversion in Periodically Poled Waveguides.

Quantum Entangled Sources based on Third-Order Interactions.

Entanglement Utilizing Complex Pump Mode Patterns.

High-Order Entanglement.

Pixel Entanglement and Secure Transmission of Images.

Unified Theoretical Framework for Classical and Quantum Imaging.

Quantum Laser Radar

Primary goal is to use noiseless preamplification (phase sensitive amplification) to increase sensitivity of laser radar.

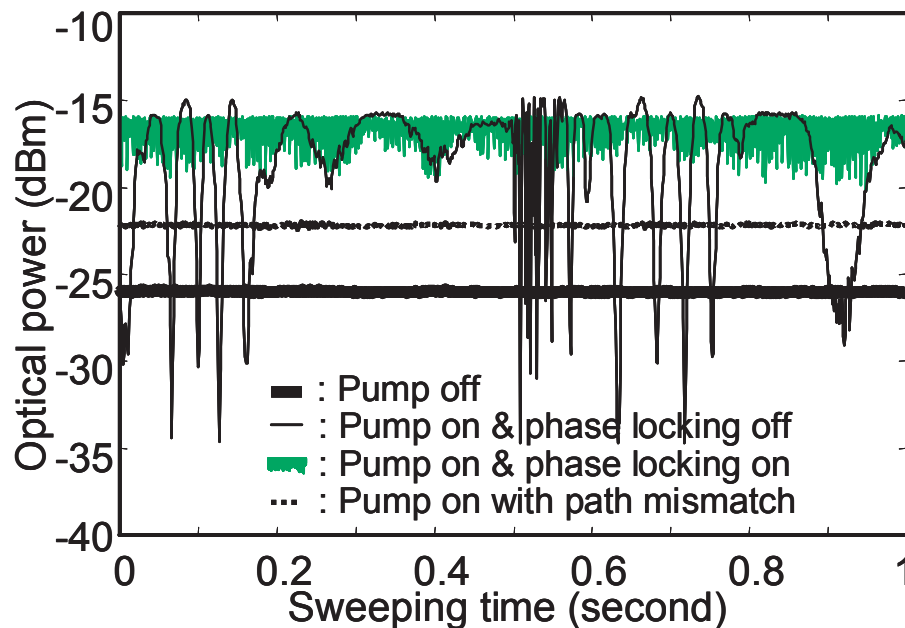

Quantum Optical Coherence Tomography

Classical

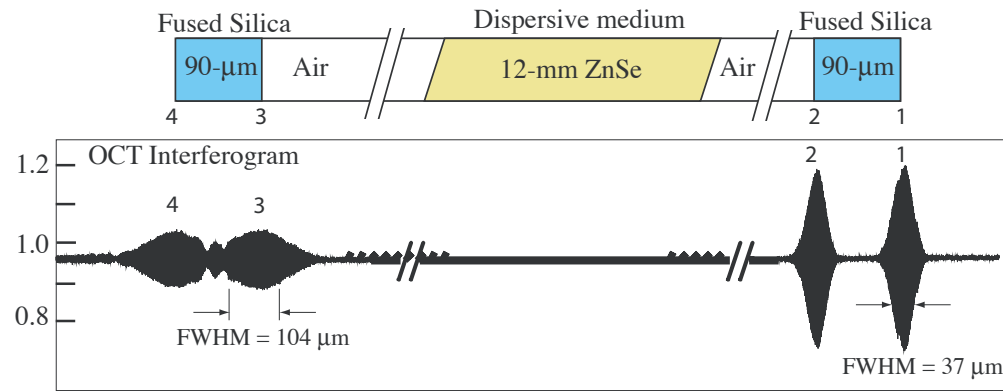
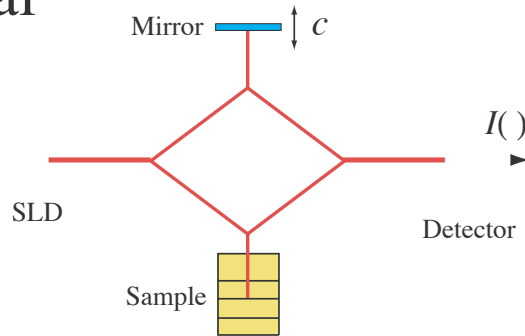

Quantum

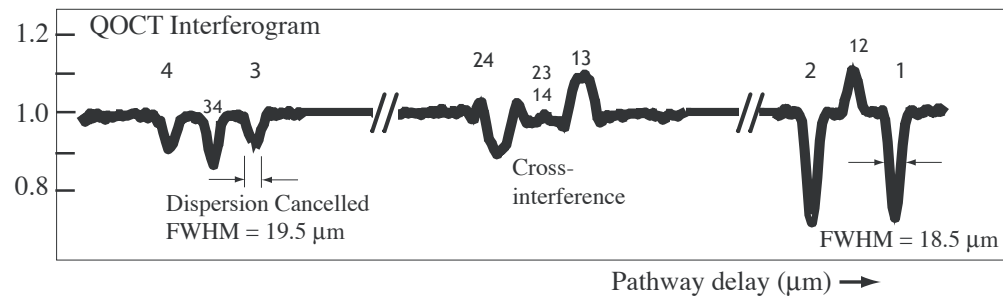
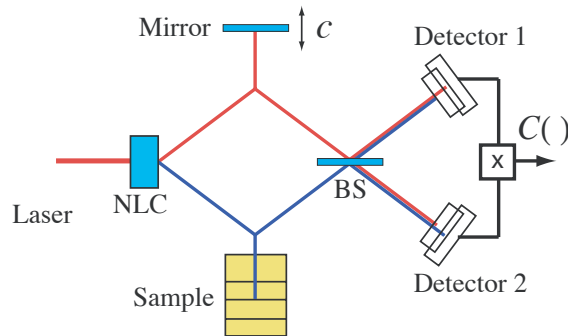

Quantum OCT offers three advantages over classical:

Factor-of-two better spatial resolution

Dispersion cancellation

Cross-interference provides additional information

Nonlocal Quantum Spatial Correlations Induced by Pump Beams Carrying Orbital Angular Momentum

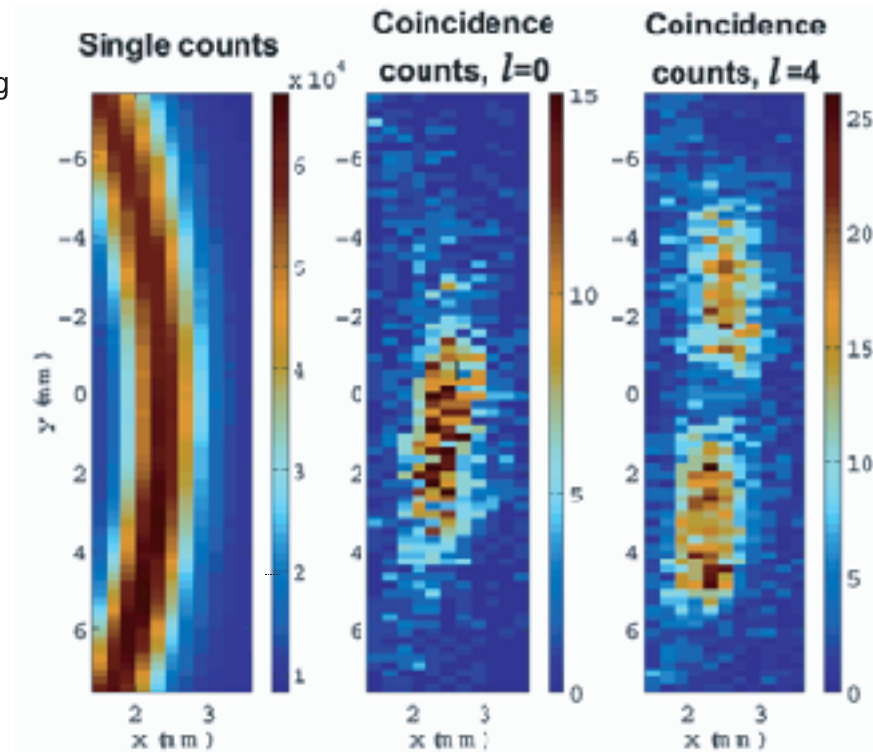
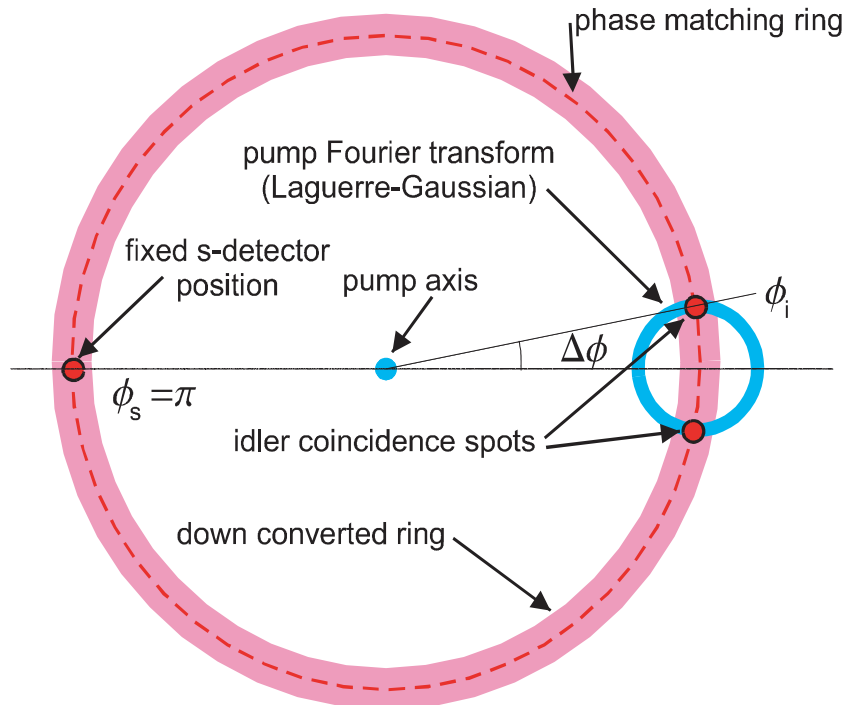

- Image information encoded on pump beam leads to quantum correlations in the down-converted photons.
- Demonstrates entanglement of orbital angular momentum.

Altman, Kumar, Barbosa, et al., PRL 94 123601 (2005).

Advantages of x - p entanglement

Compared to other kinds of continuous entanglement (squeezed fields, macroscopic spin), twin-photon spatial entanglement has several advantages:

- easy to produce
- easy to measure
- not degraded by optical loss
- many possible states (100's) for quantum info
 - pixel cryptography
 - image teleportation
 - ?

Uncertainty Product: Classical Versus Quantum

- The image resolution can be quantified by the width of the point spread function.
- For images obtained with our **classical source**, we find that the uncertainty product is given by

$$(\Delta x_2)_{x_1}^2 (\Delta k_2)_{k_1}^2 = 2.2 \pm 0.2$$

which in agreement with theory is larger than unity.

- For images obtained with **entangled photons**, we find that the uncertainty product is given by

$$(\Delta x_2)_{x_1}^2 (\Delta k_2)_{k_1}^2 = 0.01 \pm 0.03$$

which is 100 times smaller than the limiting value of unity.

- Thus, nonclassical behavior has been observed.

Remote (Ghost) Spectroscopy

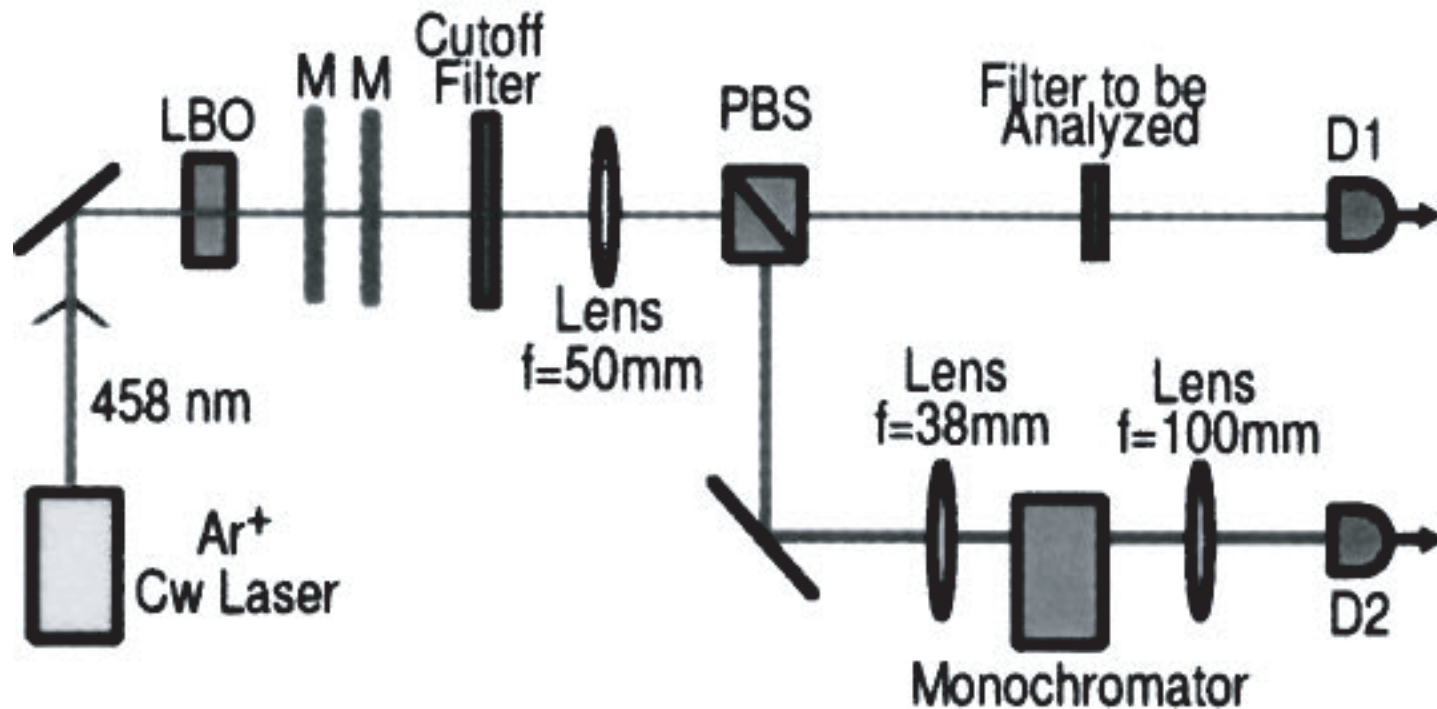

Can this idea be implemented with thermal light?

Scarcelli, Valencia, Compers, and Shih, APL 83 5560 2003.

See also the related work of Bellini et al., Phys. Rev. Lett. 90 043602 (2003).