

My Interactions with Ray Chiao and How He Influenced My Education

Robert W. Boyd
Institute of Optics and Department of Physics and
Astronomy
Rochester, New York

Presented at the Ray-fest, PQE, Snowbird, Utah, January 4, 2006.

Some History

I met Ray during my Freshman year at MIT. He was an assistant professor. I concluded that he must be very intelligent! (I got this one right.)

I interacted closely with Ray as a graduate student at UC Berkeley

Courses: QE and Astrophysics, Optics 208

Secondary mentor within the Chiao/Townes Group

Aside: Nobody wanted to appear stupid in front of Prof. Townes, so his students spend a lot of time presenting preliminary ideas to Ray.

Ray and Florence in Hawaii



Ray's Influence On My Career

Throughout my career, every time I strike out in a new research direction, I find that Ray had made pioneering contributions in that field, and then moved on to other topics. Here are some examples:

Stimulated Brillouin Scattering

Ray: Co-discoverer of SBS (PRL, 1964)

Me: Demonstrate slow light (large group delay) based on SBS (PRL, 2005)

Self-Trapping of Light

Ray: Co-predictor of self-trapping (PRL, 1964)

Me: Observe honeycomb pattern formation in self-focusing (PRL, 2002)

Entangled-Photon Interference

Ray: Demonstrate Franson Interference (PRA, 1993)

Me (& Howell): Observe entanglement in a large Hilbert space (PRL, 2005)

Superluminal Propagation of Light

Ray: Predicts superluminal (but causal) light propagation (PRA, 1993)

Me: Observe fast and slow light in room temperature solids (Science, 2003)

Numerical Modeling of Pulse Propagation Through Slow and Fast-Light Media

Numerically integrate the paraxial wave equation

$$\frac{\partial A}{\partial z} - \frac{1}{v_g} \frac{\partial A}{\partial t} = 0$$

and plot $A(z,t)$ versus distance z .

Assume an input pulse with a Gaussian temporal profile.

Study three cases:

Slow light $v_g = 0.5 c$

Fast light $v_g = 5 c$ and $v_g = -2 c$

Pulse Propagation through a Slow-Light Medium ($n_g = 2$, $v_g = 0.5 c$)

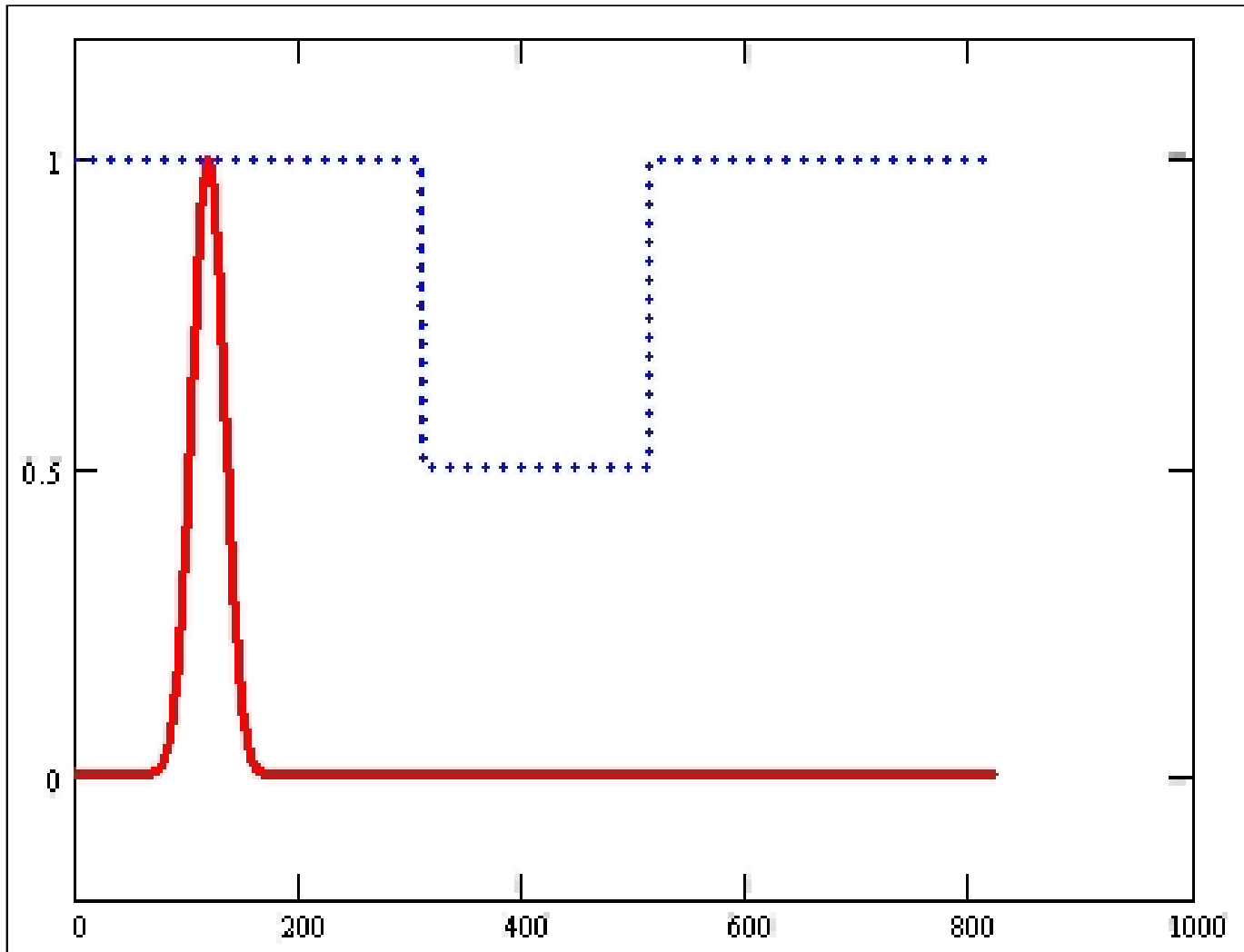

Pulse Propagation through a Fast-Light Medium ($n_g = .2$, $v_g = 5 c$)

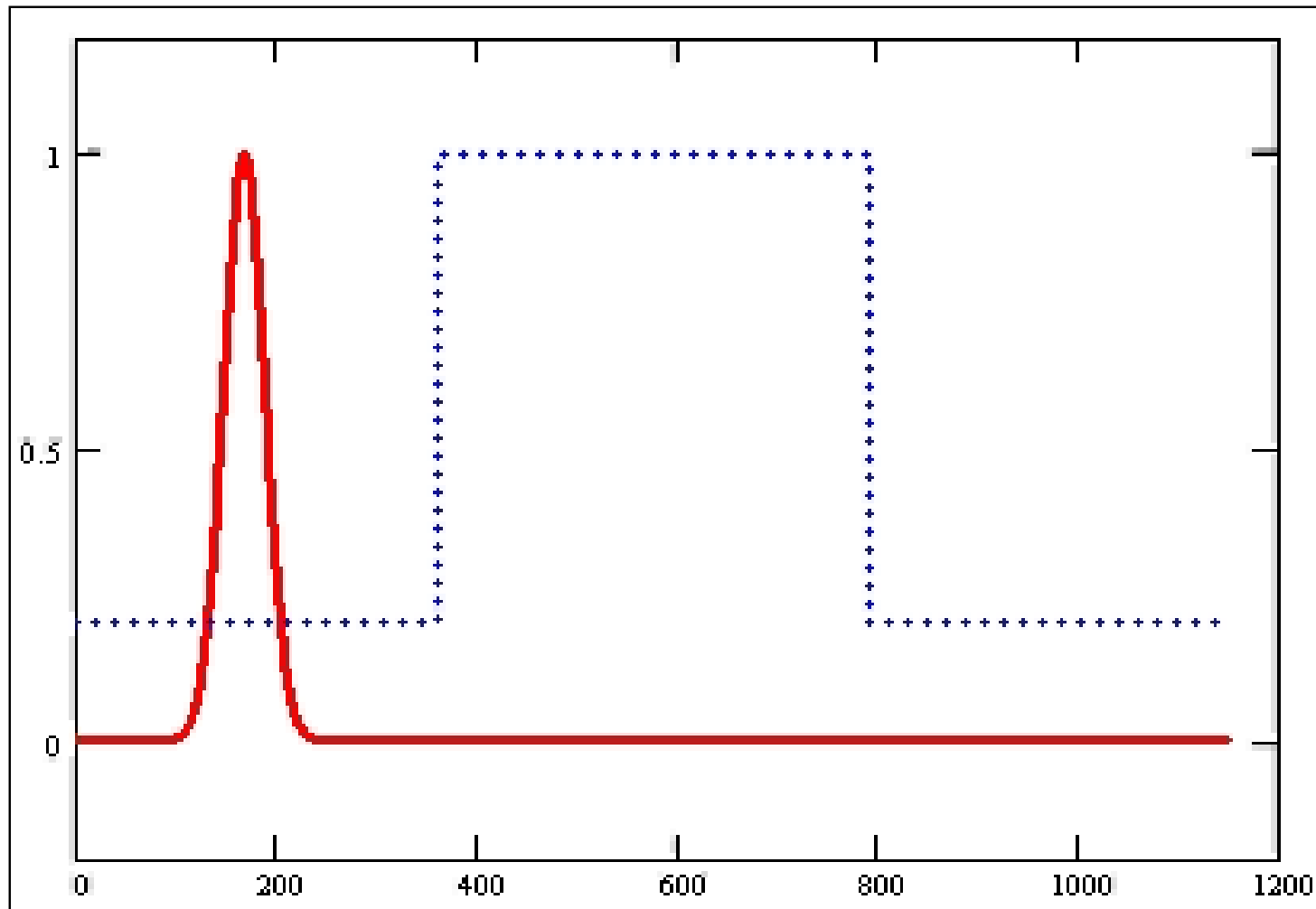

Pulse Propagation through a Fast-Light Medium ($n_g = -.5$, $v_g = -2 c$)

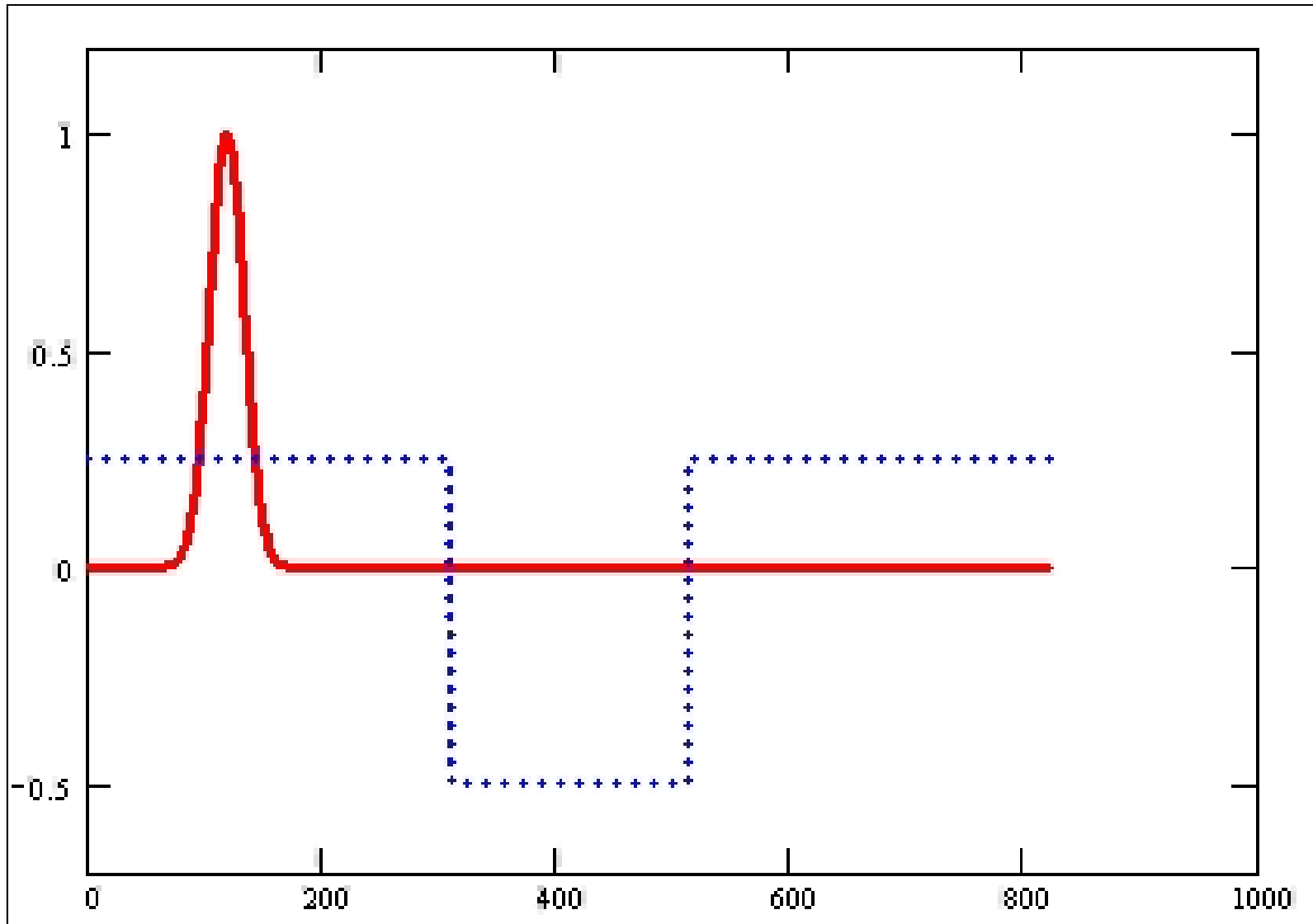

Slow and Fast Light in an Erbium Doped Fiber Amplifier

- Fiber geometry allows long propagation length
- Saturable gain or loss possible depending on pump intensity

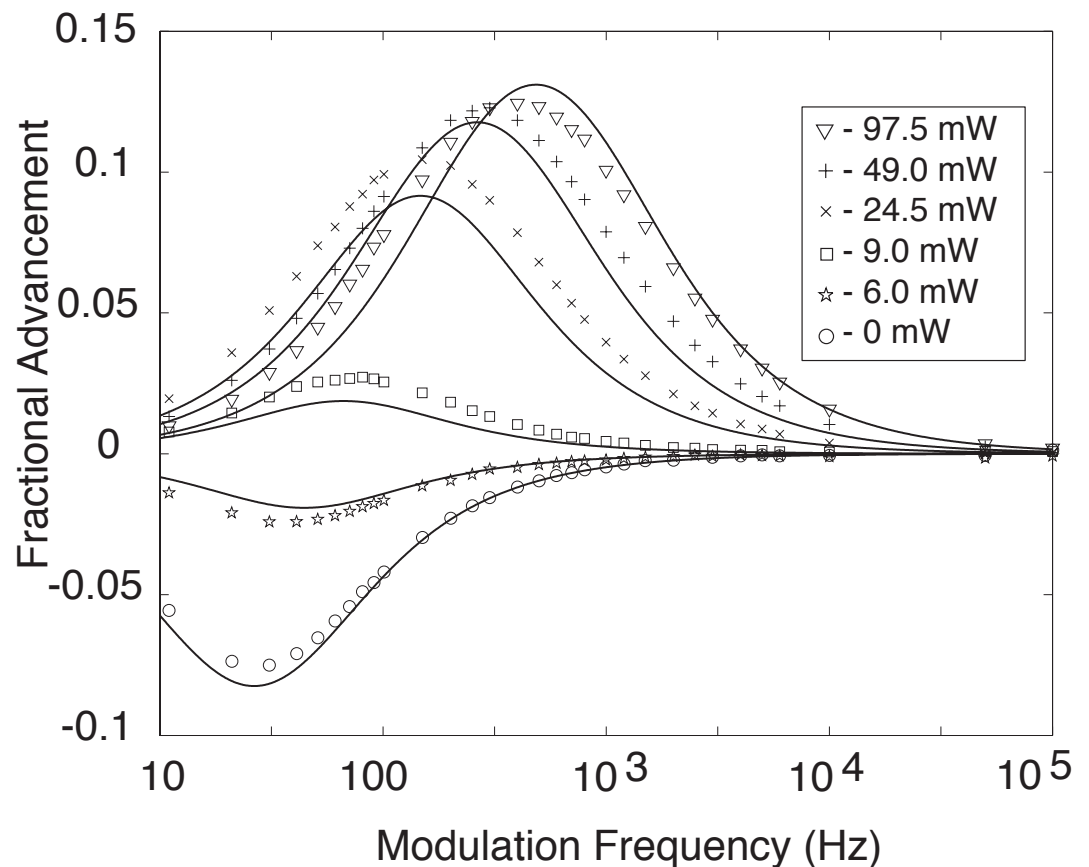
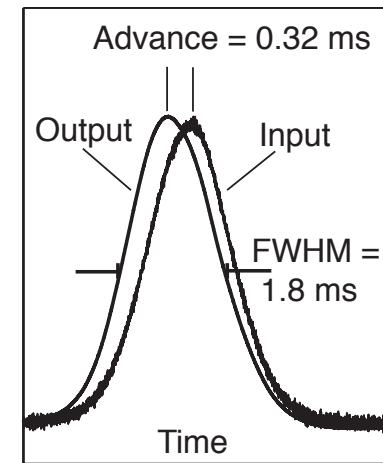
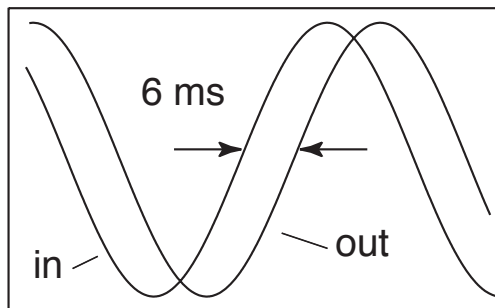
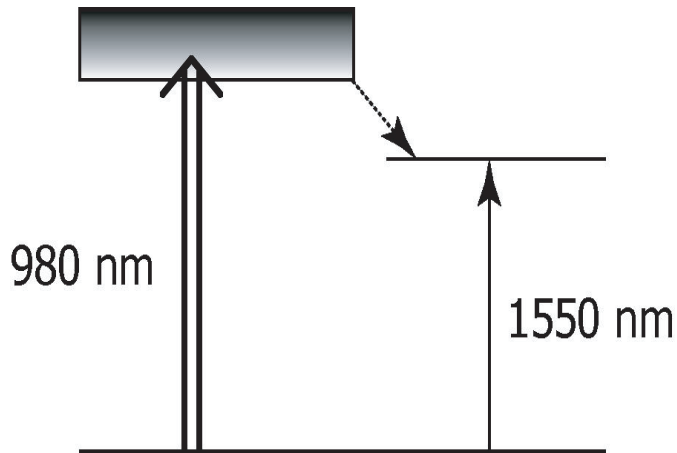

Observation of Backward Pulse Propagation in an Erbium-Doped-Fiber Optical Amplifier

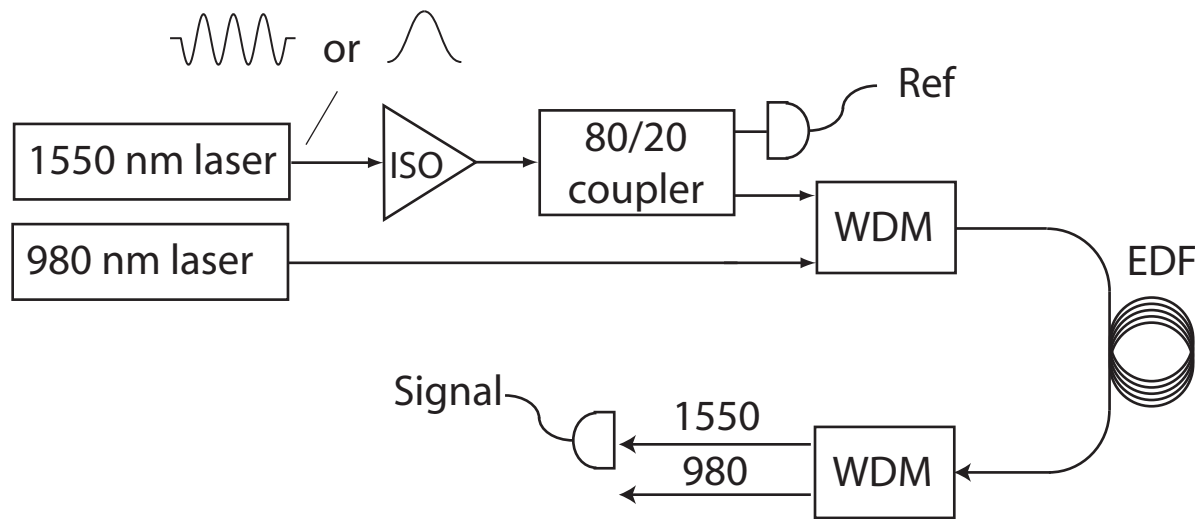

We time-resolve the propagation of the pulse as a function of position along the erbium-doped fiber.

Procedure

- cutback method
- couplers embedded in fiber

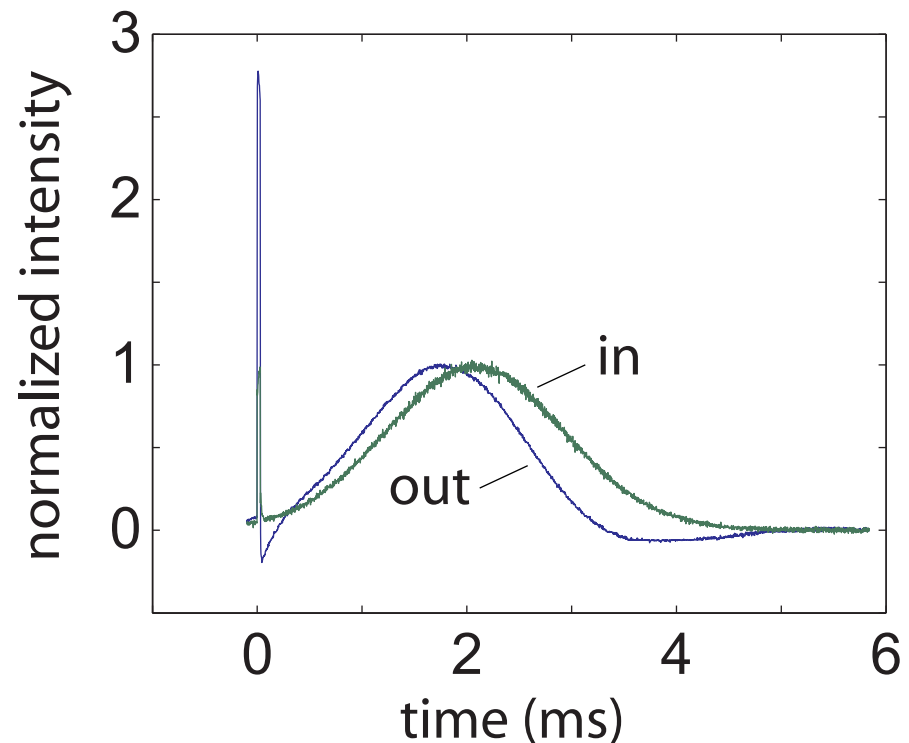

Experimental Results: Backward Propagation in Erbium-Doped Fiber

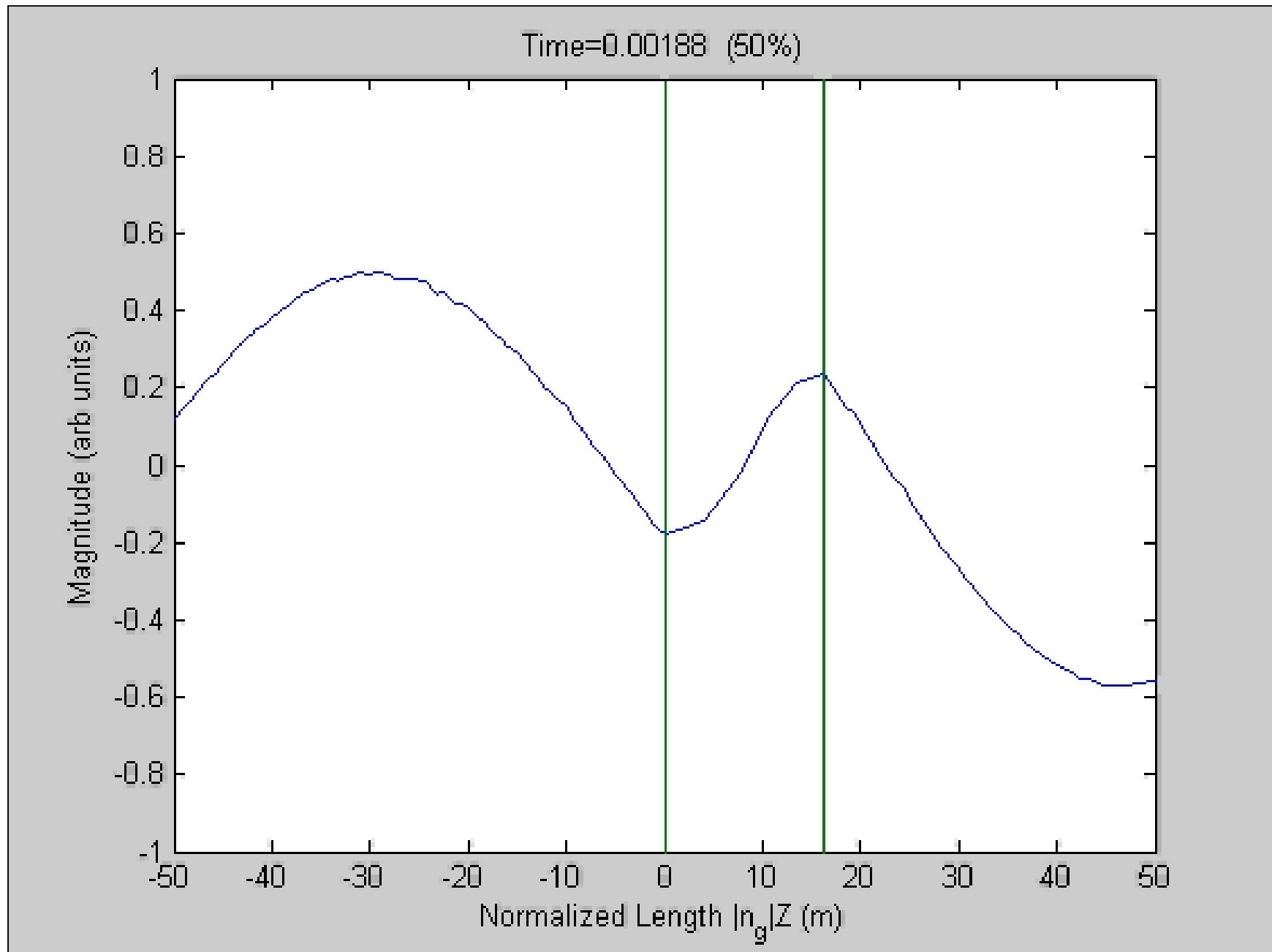

Observation of Backward Pulse Propagation in an Erbium-Doped-Fiber Optical Amplifier

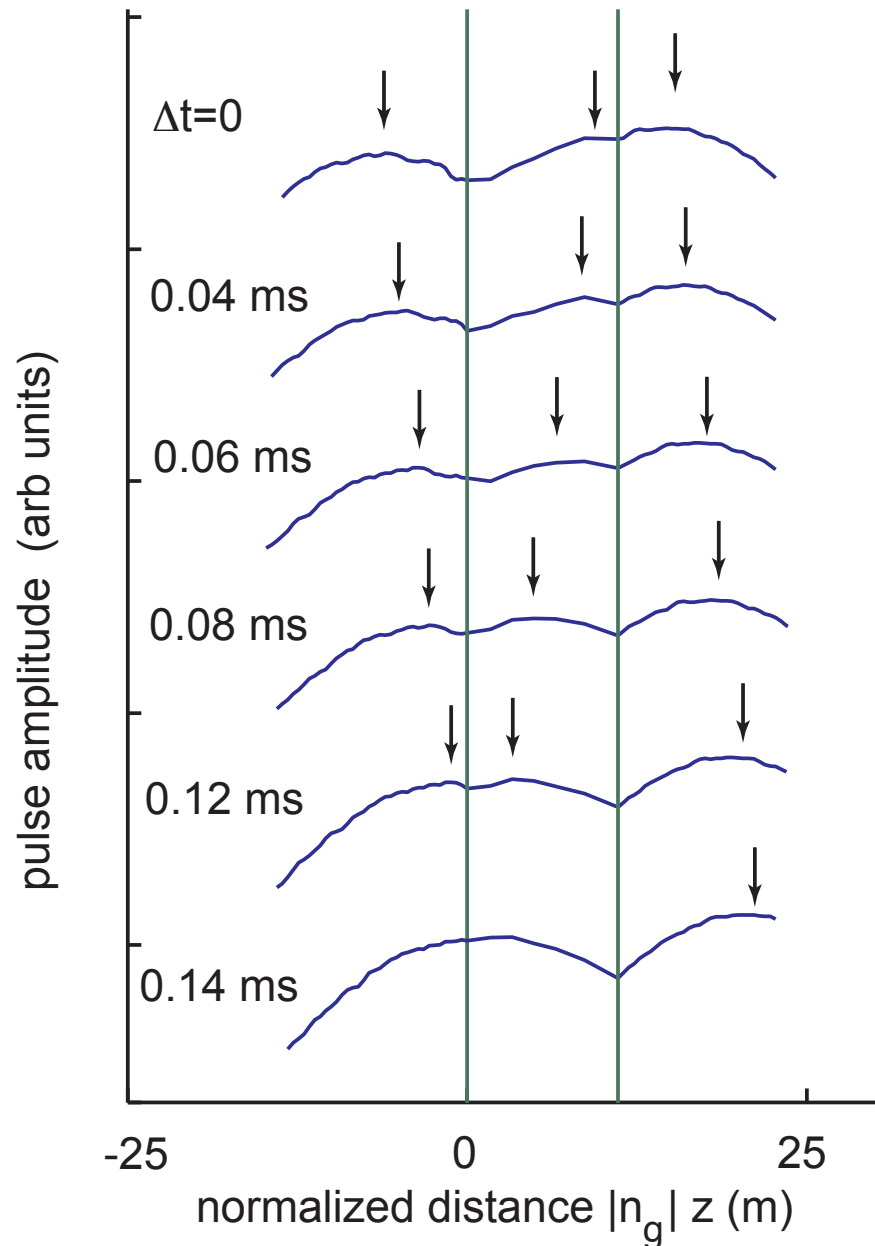

Observation of Backward Pulse Propagation in an Erbium-Doped-Fiber Optical Amplifier

Summary:

“Backwards” propagation is a realizable physical effect.

Thank you for your attention!



めがね之碑

眼鏡がはるかに海を
越え我が日本に渡
来したのは四百二十
余年前のことであり
まア文化の發達に
つれてめがねの需要
も増大し文化政治
経済に貢獻した役
割は誠に大なるもの
のがありますその間
業界先覚者の研鑽
努力により今日の
發展をみるに至つ
たことを回想
明治百年を記念し
てその功績を顕彰
し慈眼大師ゆかり
の地と野不忍地呼
ぶこの碑を建立し
感謝の念を新たに
するものでありま