



The Promise of Quantum Nonlinear Optics

Robert W. Boyd

Department of Physics and
School of Electrical Engineering and Computer Science
University of Ottawa

The Institute of Optics and
Department of Physics and Astronomy
University of Rochester

The visuals of this talk will be posted at boydnlo.ca/presentations

Presented at the IEEE Photonics Conference, Vancouver BC, Canada, November 13, 2022.

The Promise of Quantum Nonlinear Optics

What is Quantum Nonlinear Optics?

Quantum Optics uses weak light beams

Nonlinear Optics uses intense light beams

Examples where both quantum and nonlinear features are important:

- Stimulated Raman Scattering is initiated by quantum noise (zero-point fluctuations)
- The most common source of entangled photons is spontaneous parametric downconversion (SPDC), a nonlinear optical process.

Parametric Downconversion: A Source of Entangled Photons

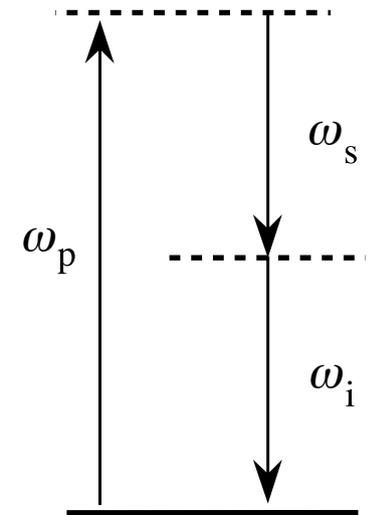
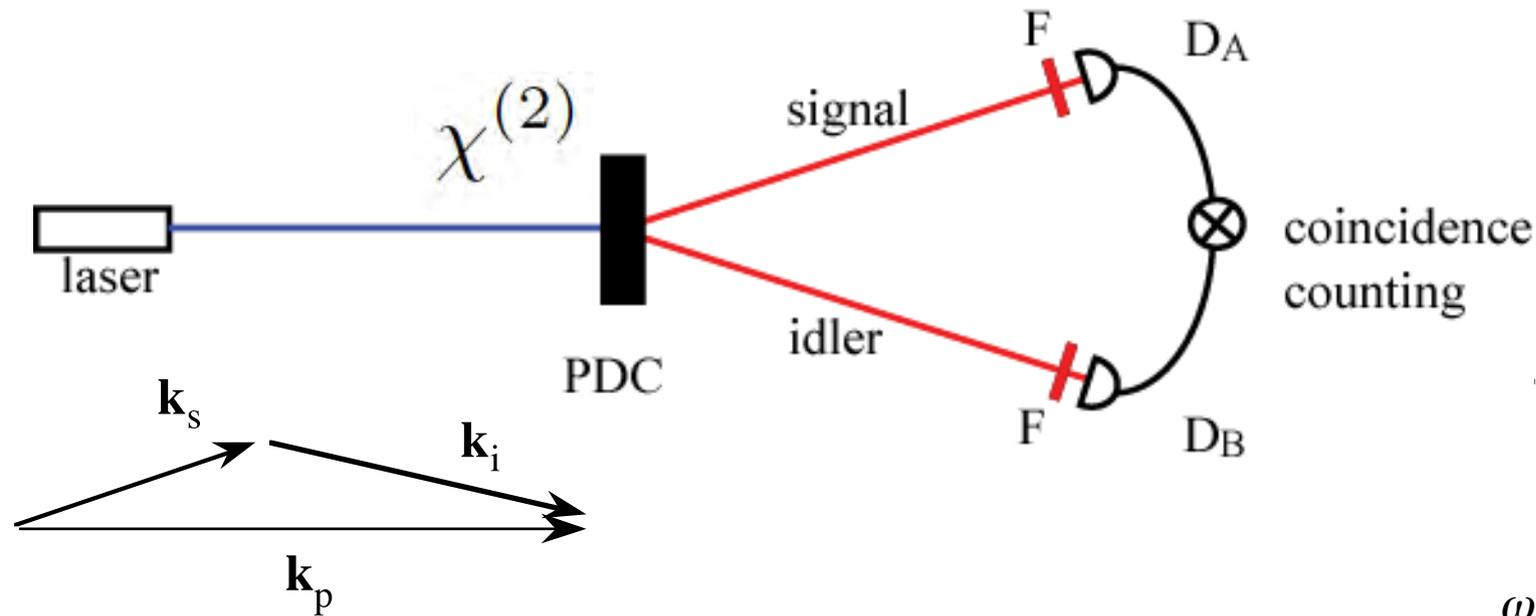

The signal and idler photons are entangled in:

- (a) polarization
- (b) time and energy
- (c) position and transverse momentum
- (d) angular position and orbital angular momentum

Entanglement is important for:

- (a) Fundamental tests of QM (e.g., nonlocality)
- (a) Quantum technologies (e.g., secure communications)

Squeezed Light Generation

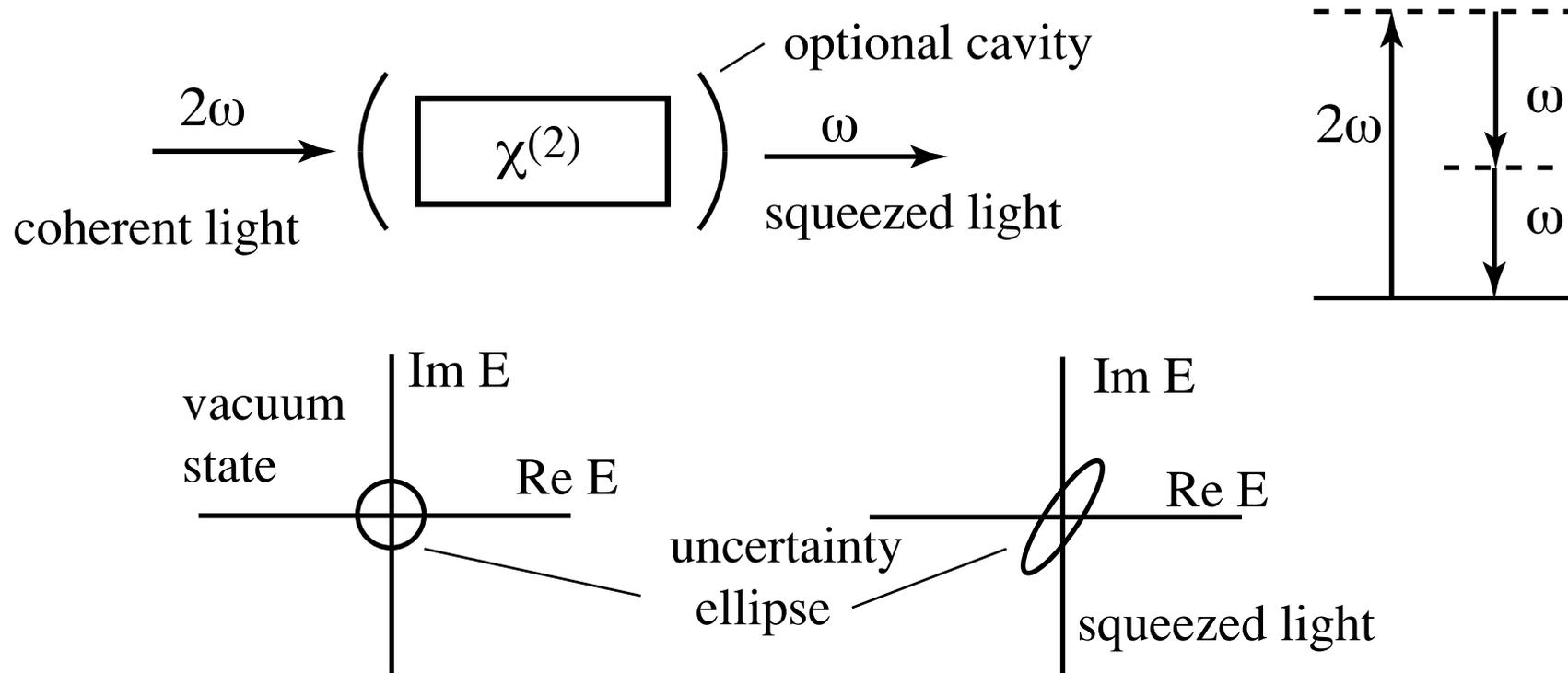

Entanglement and squeezing share a common origin. In fact:

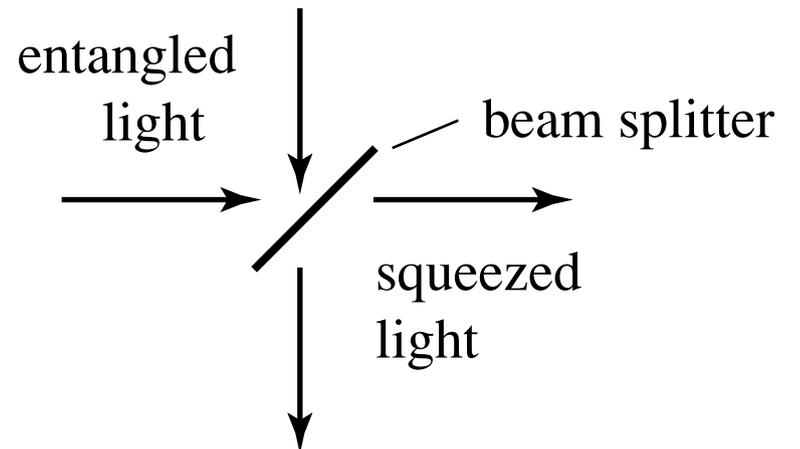

Klyshko's Method for Absolute Calibration of a Photodetector

- Absolute measurement of detector quantum efficiency (Klyshko, Sergienko, Migdall, Polyakov, etc.)

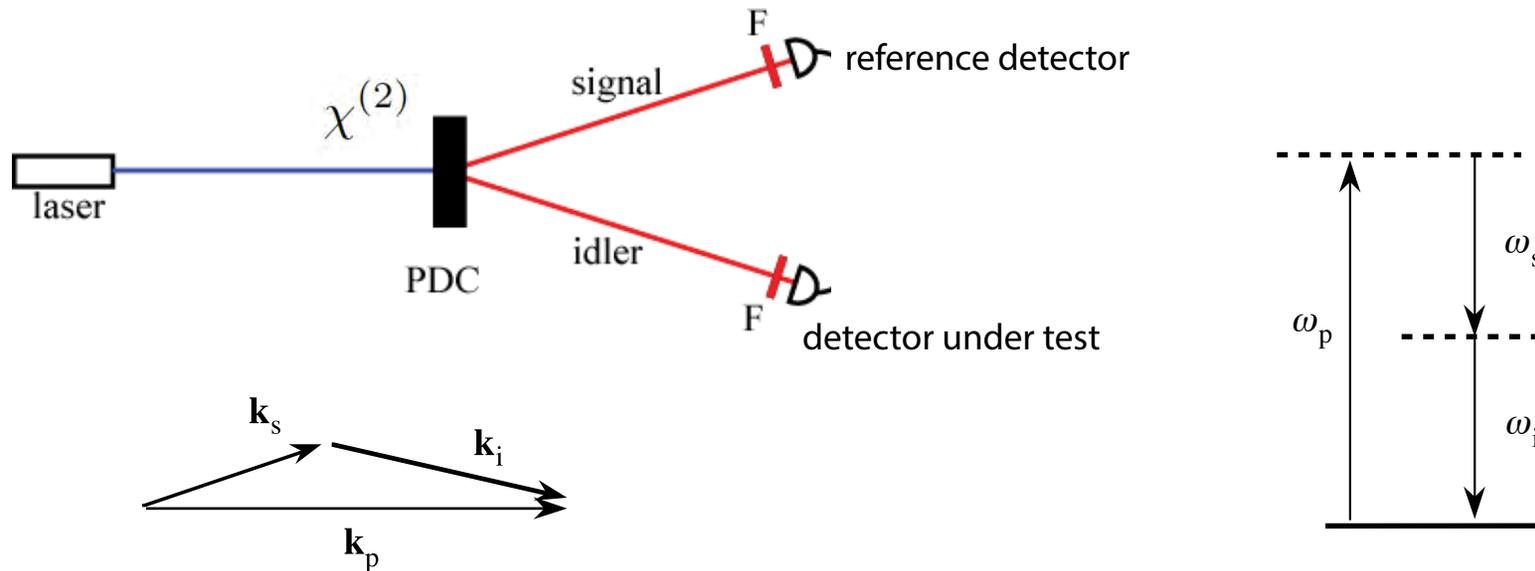

- Earlier work (Klyshko) established that the light produced by spontaneous parametric downconversion (SPDC) can be characterized in terms of the radiometric property known as brightness (or radiance).

Chip-Scale Quantum-Photonic Devices

Group of Qian Lin, University of Rochester

Makes use of a lithium niobate platform

Funding by the NSF QuIC-TAQS Program

(Quantum Interconnect Challenges for Transformational Advances in
Quantum Systems)



On-Chip Photonic Devices for Quantum Technologies

- To make quantum technologies practical, we need to develop networks of quantum devices on a single chip

- Source of correlated photons

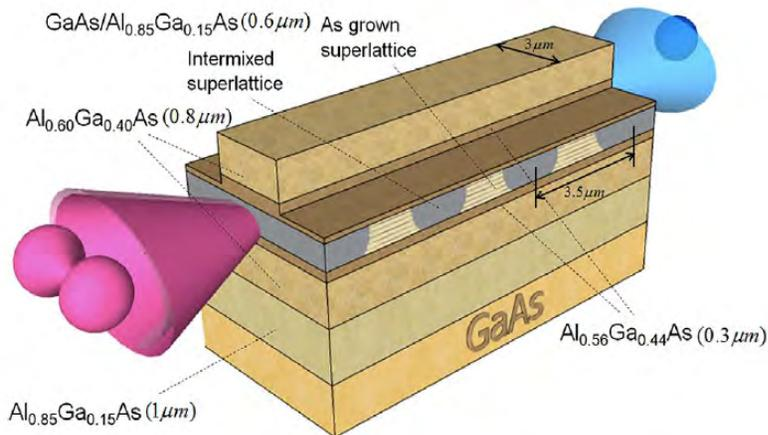

Sarrafi et al., Appl. Phys. Lett. 103, 251115 (2013).

- Strong coupling of QD to PhC resonator

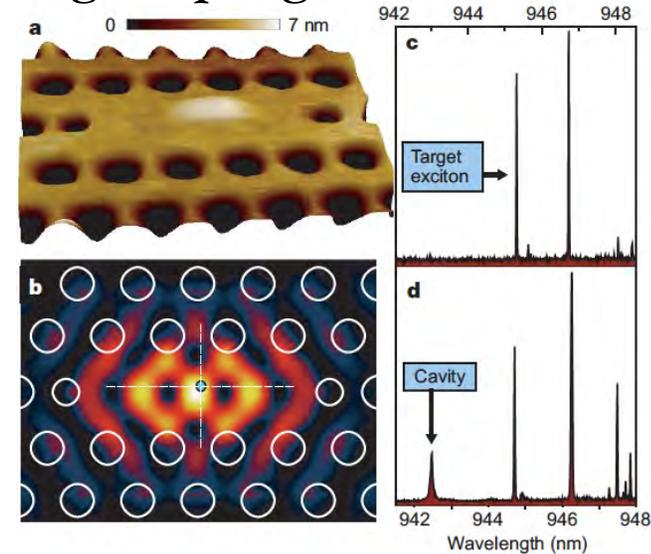

Hennessy et al., Nature 445, 896 (2007)

- Entanglement source

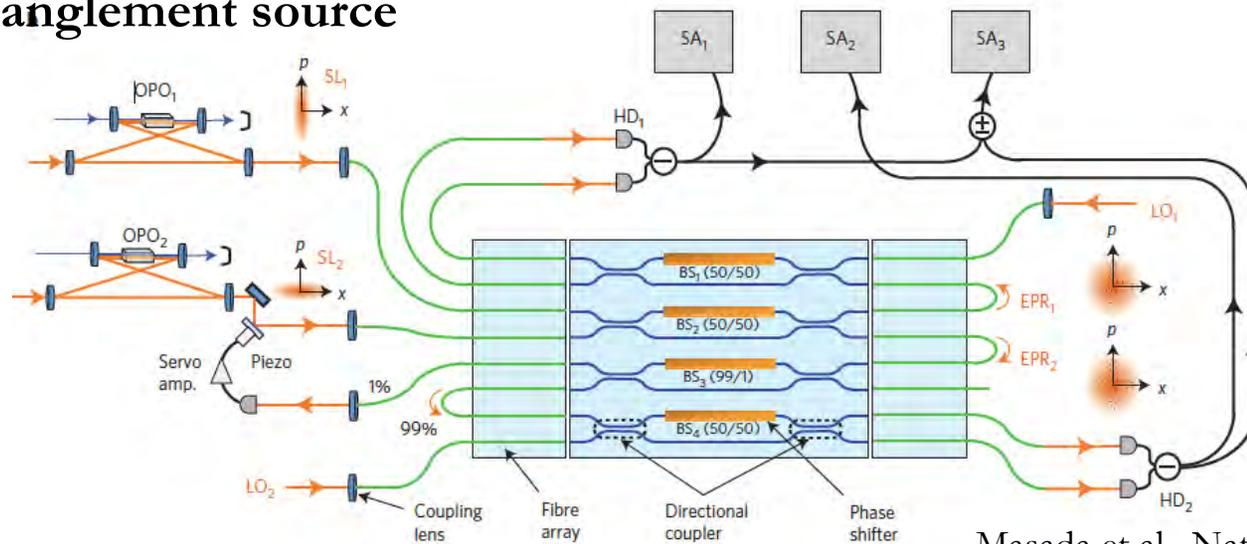

Masada et al., Nature Photonics 9, 316 (2015).

On-chip lithium niobate entangled photon pair sources

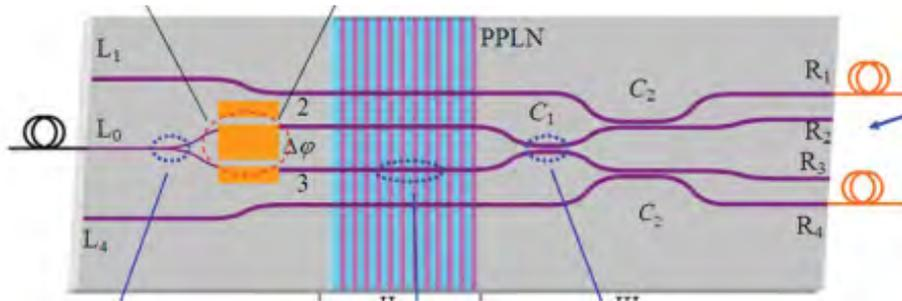

• H. Jin, et al, PRL 113, 103601 (2014).

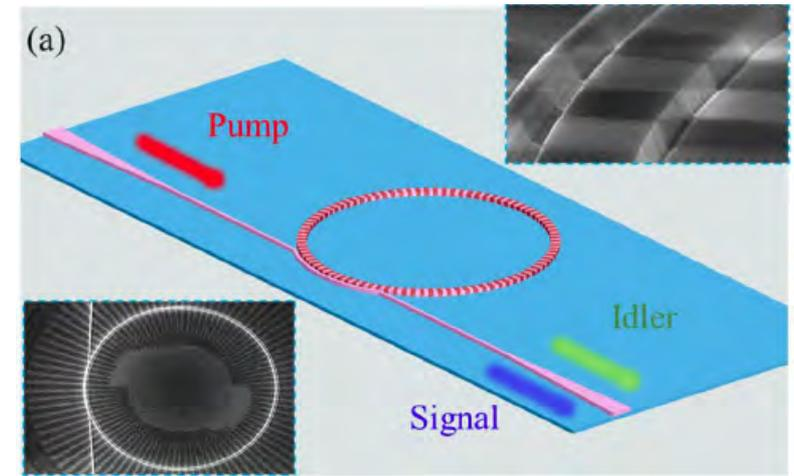

• Z. Ma, et al, PRL 125, 263602 (2020).

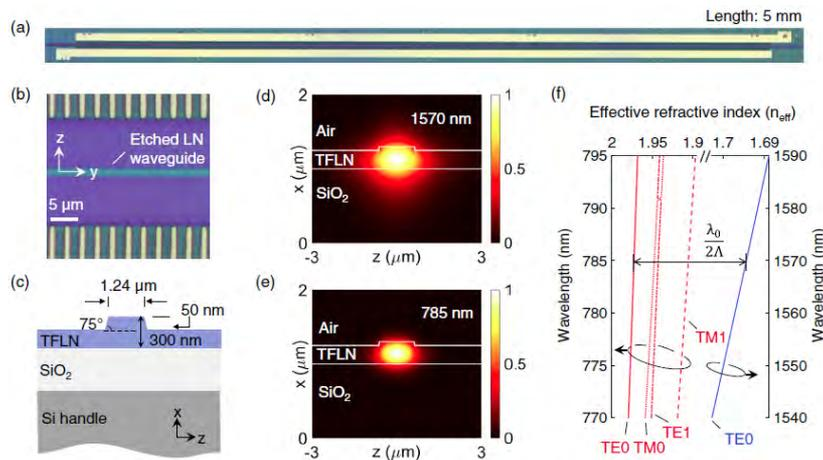

• J. Zhao, et al, PRL 124, 163603 (2020).

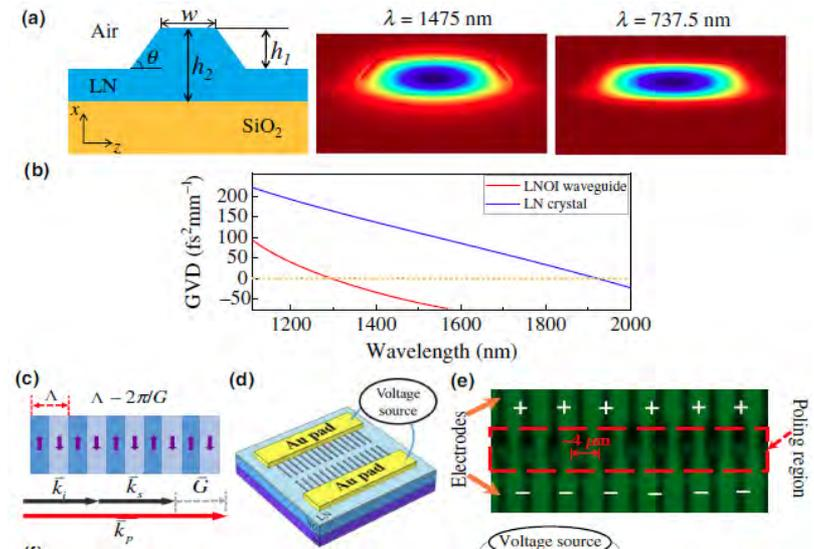

• G.-T. Xue, et al, Phys. Rev. Appl. 15, 064059 (2021).

Why lithium niobate?

Material	E_g (eV)	n_0	Transparent window (μm)	Thermo-optic coefficient $\frac{dn}{dT}$ (K^{-1})	Electro-optic coefficient (pm/V)	Quadratic nonlinearity (pm/V)	Kerr nonlinearity n_2 (cm^2/GW)	Piezoelectr- icity (pC/N)
LiNbO ₃	4.0	2.2	0.35 – 5.5	2.9×10^{-5}	$r_{33} = 30.8$ (Pockels effect)	$d_{33} = 25.2$	7.3×10^{-6}	$d_{15} = 74$
Si	1.12	3.48	1.1 – 6.5	1.8×10^{-4}	Carrier plasma effect	NA	4.5×10^{-5}	NA
SiO ₂	7.8	1.45	0.16 – 2.5	1.0×10^{-5}	NA	NA	2.6×10^{-7}	NA
Si ₃ N ₄	5	1.98	0.3 – 4.6	2.5×10^{-5}	NA	NA	2.4×10^{-6}	NA
Diamond	5.5	2.39	> 0.23	1.0×10^{-5}	NA	NA	8.2×10^{-7}	NA
GaAs	1.43	3.4	0.9 – 17.3	2.5×10^{-4}	$r_{41} = 1.2$ (Pockels effect)	$d_{14} = 105$	1.6×10^{-4}	$d_{14} = -2.7$
GaN	3.44	2.3	0.36 – 6.0	6.1×10^{-5}	$r_{33} = 1.6$ (Pockels effect)	$d_{33} = -3.8$	5.3×10^{-6}	$d_{33} = 2.1$
AlN	6	2.12	0.2 – 10	2.3×10^{-5}	$r_{33} = 1.0$ (Pockels effect)	$d_{33} = 4.7$	2.3×10^{-6}	$d_{33} = 3.4$

- Lithium niobate exhibits strong Kerr nonlinearity, quadratic nonlinearity, electro-optic Pockels effect, piezoelectric effect.
- It supports integrating nearly all photonic functionalities on a single chip.

Broadband spontaneous parametric down-conversion

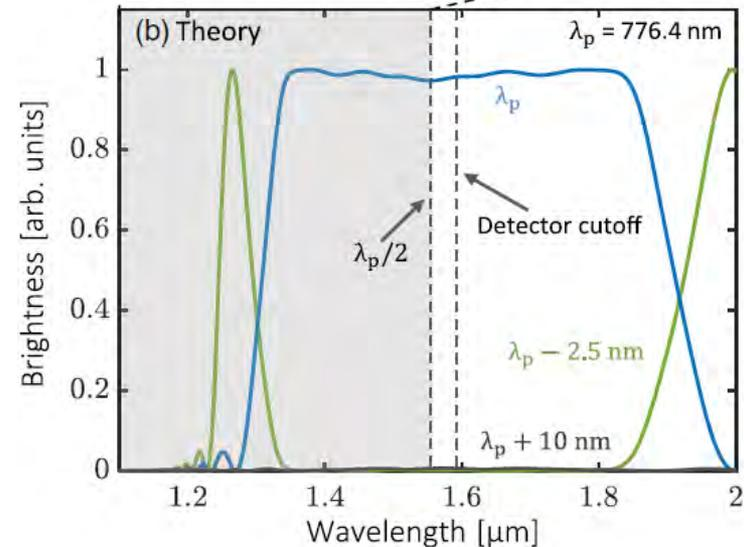
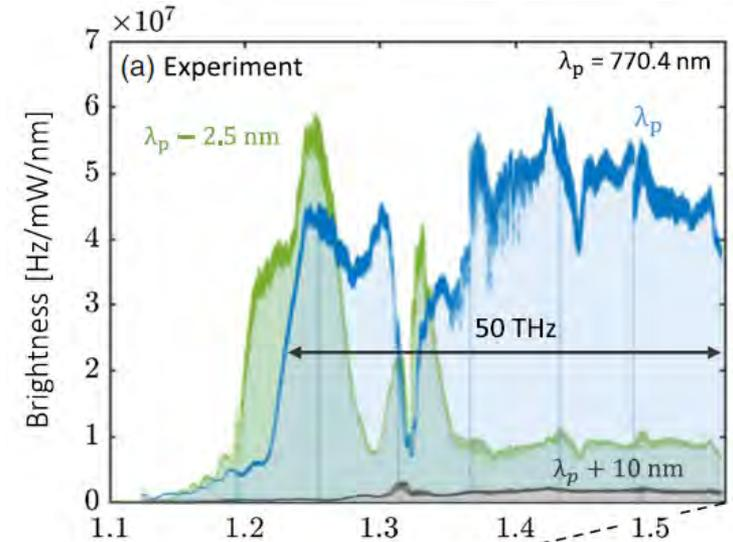
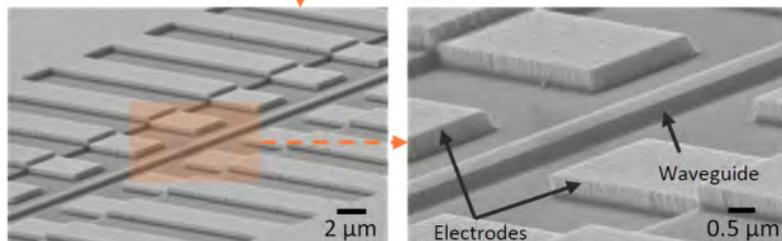
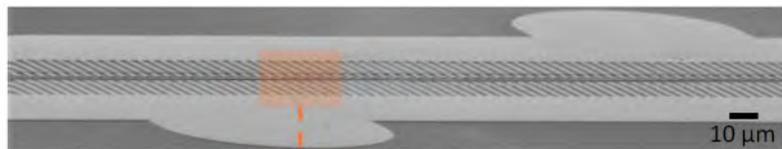
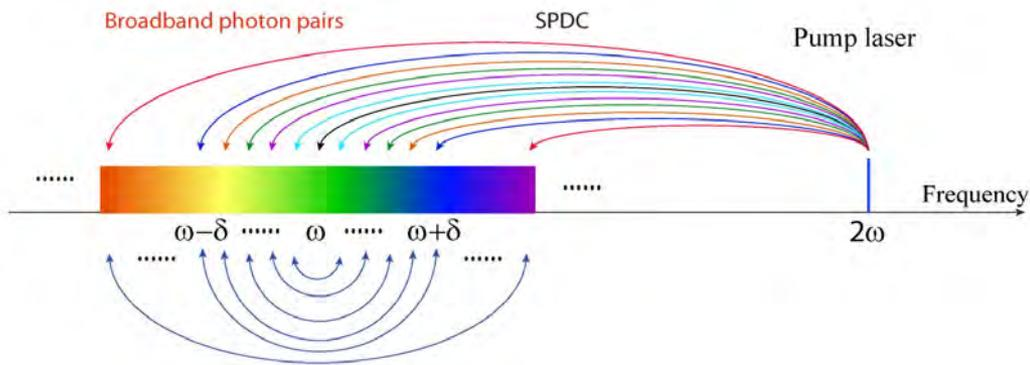
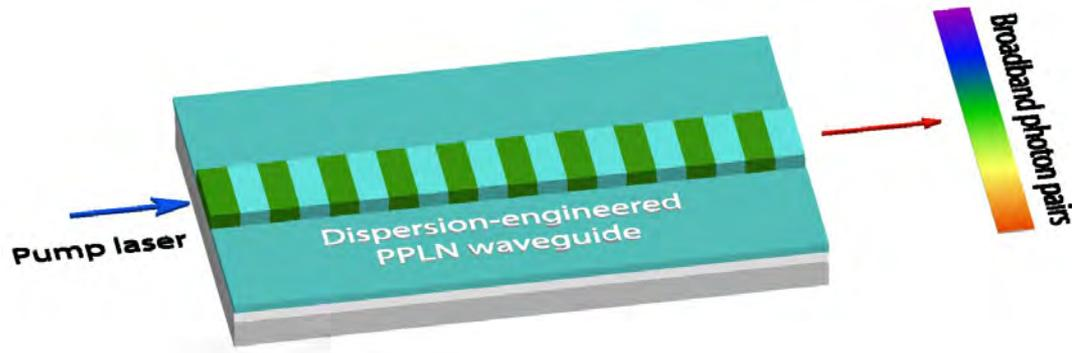

Compared to state-of-the-art

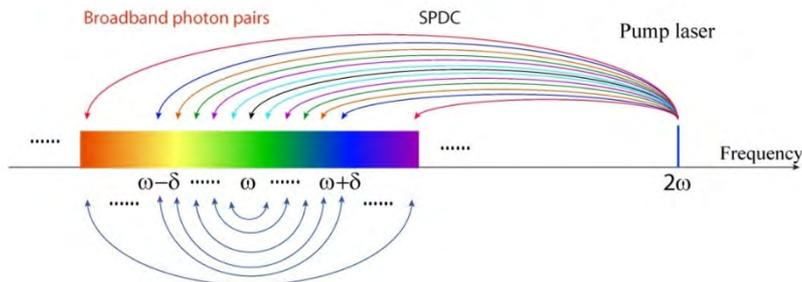
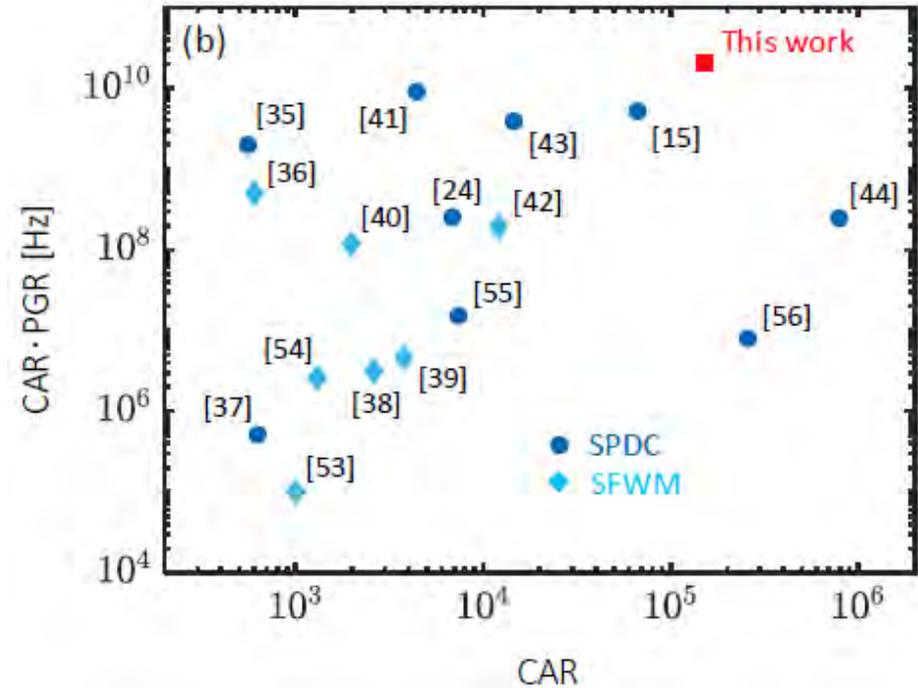
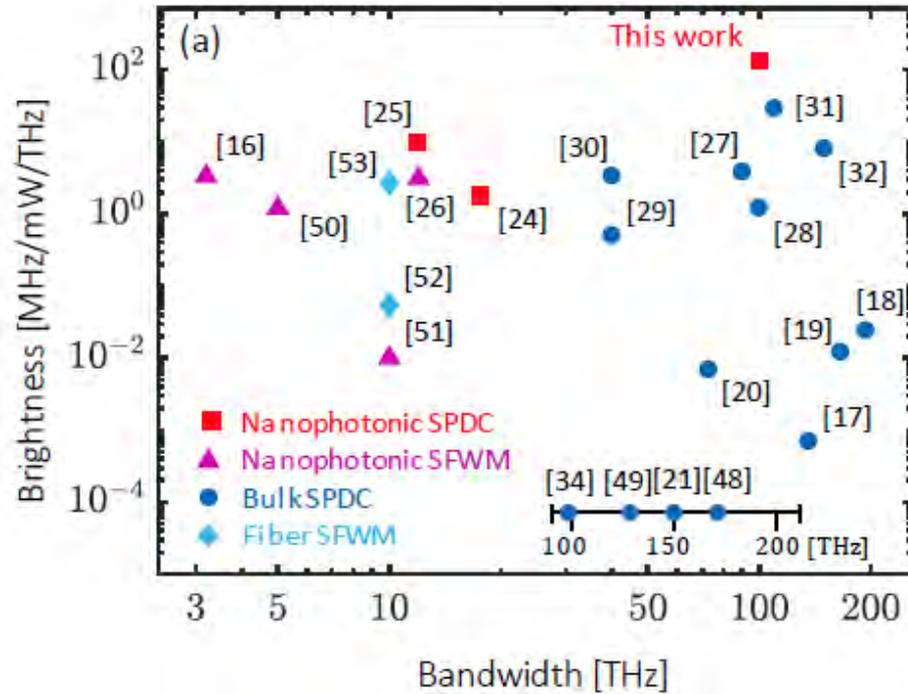

- U. Javid, *et al*, Ultrabroadband Entangled Photons on a Nanophotonic Chip, PRL 127, 183601 (2021).

Nonlinear Optics and Optical Switching

- An important application in photonic technologies is optical switching.

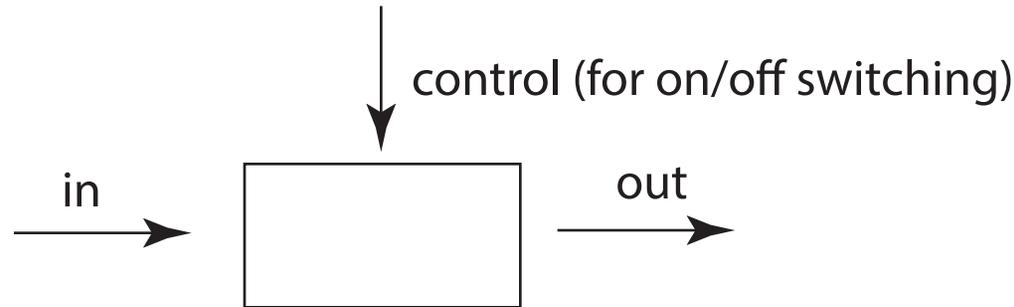

- One wants a switch with fast switching times and that operates with weak control fields.
- One needs a nonlinear interaction in order for one optical field to control another field.
- A strong nonlinear response is needed. How does one quantify the strength of a nonlinear response? Two standard methods:

$$n = n_0 + n_2 I$$

$$P^{\text{NL}} = 3\chi^{(3)} |E|^2 E$$

- The nonlinear coefficients are n_2 and $\chi^{(3)}$

Giant Nonlinear Response of ENZ Metastructures

- Nonlinear Optics is important for a variety of reasons:

Photonic Devices

All-optical switching, buffers and routers based on slow light

Used to create quantum states of light for

Quantum Computing/Communications/Imaging

Fundamental understanding of light-matter interactions

Not “just” Lorentz oscillator formalism

Understand rogue waves

Induce and control filamentation processes

- However, the nonlinear response is usually much weaker than the linear response
- Means to enhance the nonlinear response
 - Resonance interactions (atomic vapors)
 - Plasmonic systems
 - Electromagnetically induced transparency (EIT)
 - Metamaterials (composite materials)
- Our approach: Use epsilon-near-zero (ENZ) materials and metamaterials

Materials for Quantum (and Classical) Photonics

- We need highly nonlinear, low-loss materials for optical switches and gates. (Ideally, we want the control field to contain at most several photons.)

- Note that optical nonlinearities are strongly enhanced at wavelengths for which $n \approx 0$. (This is the ENZ, epsilon-near-zero, condition.)

$$n_2 = \frac{3\chi^{(3)}}{4\epsilon_0 c n_0 \text{Re}(n_0)}$$

- Note further that for any conductor $\text{Re } \epsilon = 0$ at the reduced plasma frequency:

$$\epsilon(\omega) = \epsilon_\infty - \frac{\omega_p^2}{\omega(\omega + i\gamma)}$$

- For indium tin oxide (ITO), $\text{Re } \epsilon = 0$ at $\lambda = 1.24 \mu\text{m}$.

- Application: Adiabatic wavelength conversion

- We can controllably shift the carrier wavelength of a data-encoded light field by as much as 100 nm.

$$\delta\omega(t) = \frac{d}{dt}\phi_{\text{NL}} = \frac{d}{dt}[n_2 I(t)\omega/c]$$

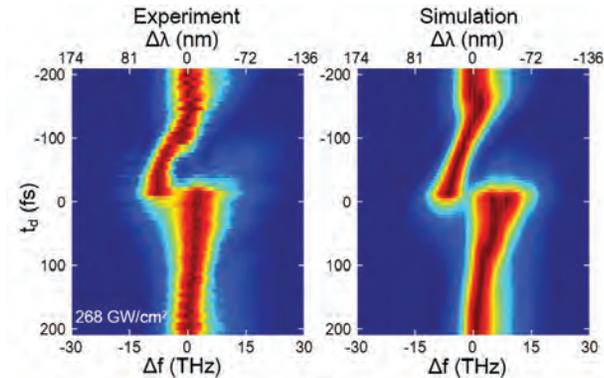

- Application: Ultrafast real-time holography

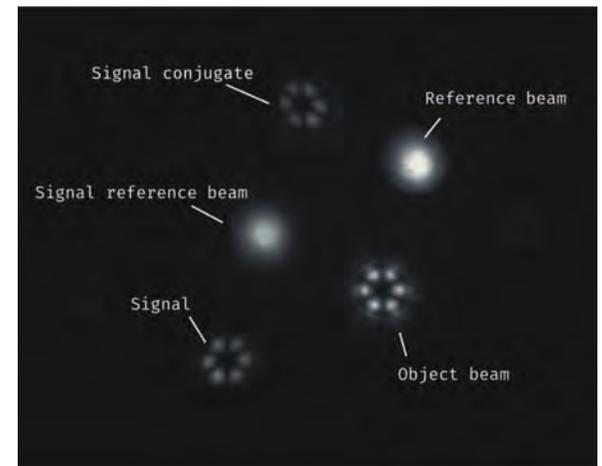

• ellipsometry

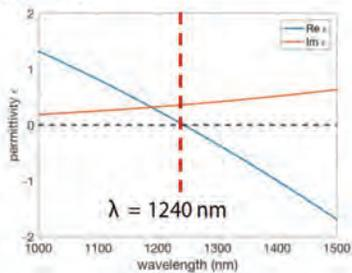

• n_2 can be 3.4×10^5 times larger than that of silica glass

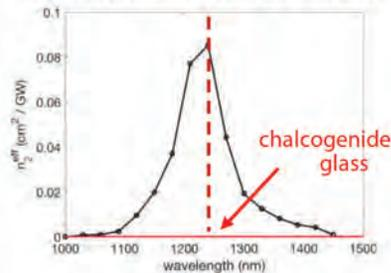

• overall change in refractive index of 0.8

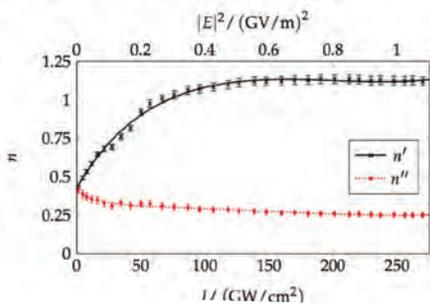

• sub picosecond response time

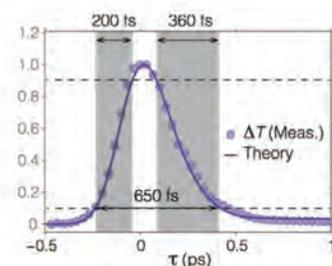

M. Z. Alam et al., Science 352, 795-797 (2016)

How to Choose an Epsilon-Near-Zero Materials

- Electrical conductors

All conductors display ENZ behavior at their (reduced) plasma frequency

Recall the Drude formula

$$\epsilon(\omega) = \epsilon_{\infty} - \frac{\omega_p^2}{\omega(\omega + i\gamma)}$$

Note that $\text{Re } \epsilon = 0$ for $\omega = \omega_p / \sqrt{\epsilon_{\infty}} \equiv \omega_0$.

ENZ wavelength restricted to a limited range in the visible.

- Electrical insulators (dielectrics)

Dielectrics can show ENZ behavior at their (optical) phonon resonance.

ENZ wavelength restricted to a limited range in the mid-IR.

- Metamaterials

Can design the material so that the ENZ or EMNZ wavelengths are at any desired value.

- Challenge (for any material system). For low loss, we want $\text{Im } \epsilon$ as small as possible at the wavelength where $\text{Re } \epsilon = 0$.

Relaxed Phase-Matching Requirements in ENZ Media

- We study four-wave mixing in a zero-index waveguide

$$2\omega_p = \omega_s + \omega_i$$

- We find that an idler field is generated in both the forward and backward directions!

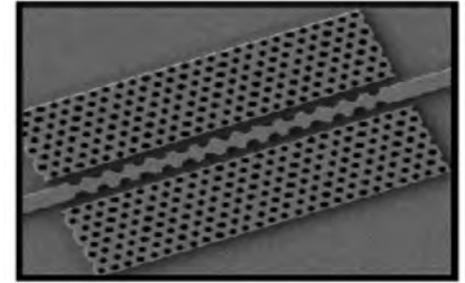

- Recall that we need $\Delta k = 0$, but when $n = 0$, $k = n \omega / c$ vanishes for each of the interacting waves and thus so does Δk .

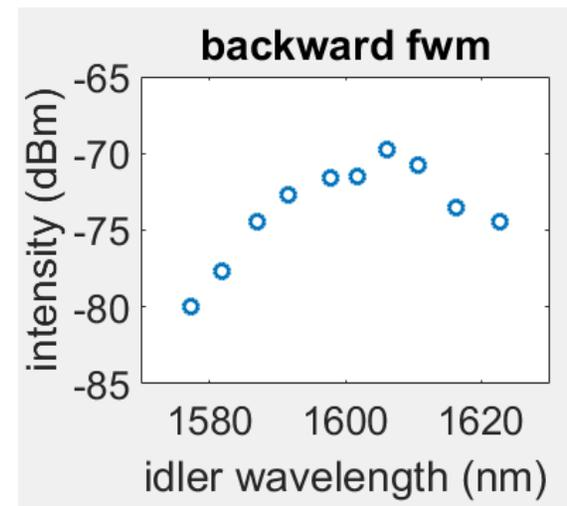
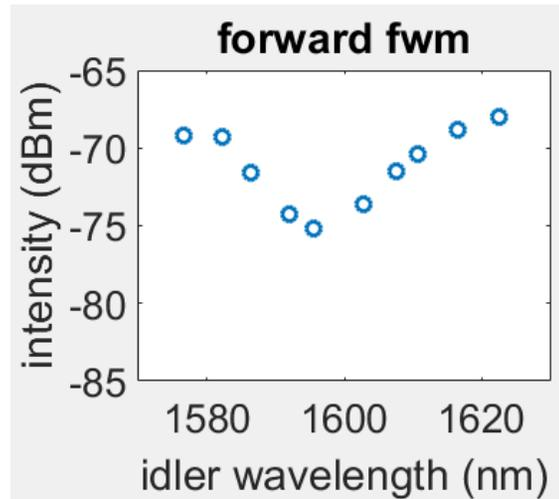

- Significance: Nonlinear optical processes that were previously believed to be too weak to be useful can be excited through use of ENZ materials.

Nonlinear Optical Properties of a Layered Metamaterial in its ENZ Region

Do layered metamaterials also show enhanced NLO response at ENZ wavelength?

Can we use an effective-medium value of epsilon to determine the ENZ wavelength?

- By controlling the metallic fill fraction ρ , we can set the ENZ wavelength to be anywhere from 300 to 700 nm. We use $\rho = 0.2$, which corresponds to 500 nm. We deposit five layer pairs

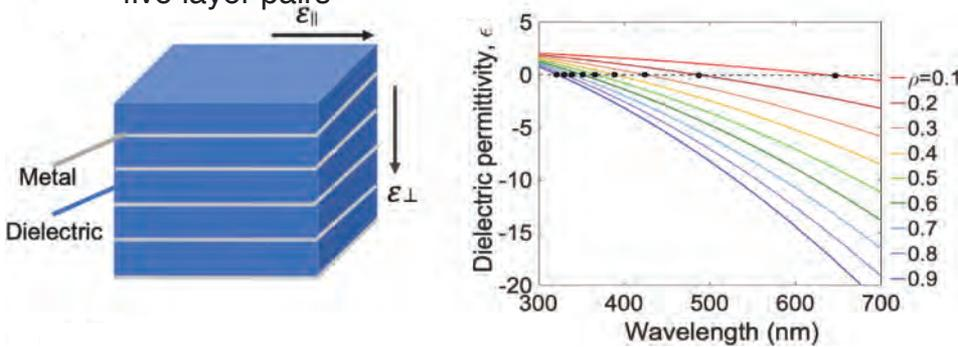

- Note that the real part of epsilon vanishes at 508 nm, close to the design wavelength. The SEM shows our structure. Ag thickness = 16 nm; silica thickness = 65 nm

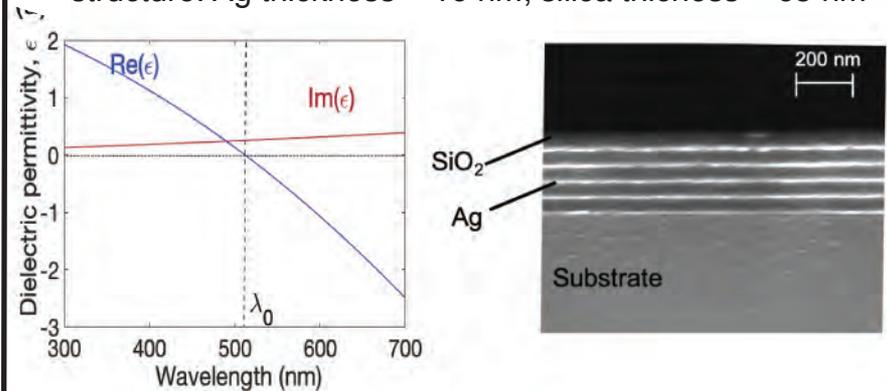

- We perform Z-scan measurements on the sample. Note the enhanced response of the composite as compared to a single layer of silver.

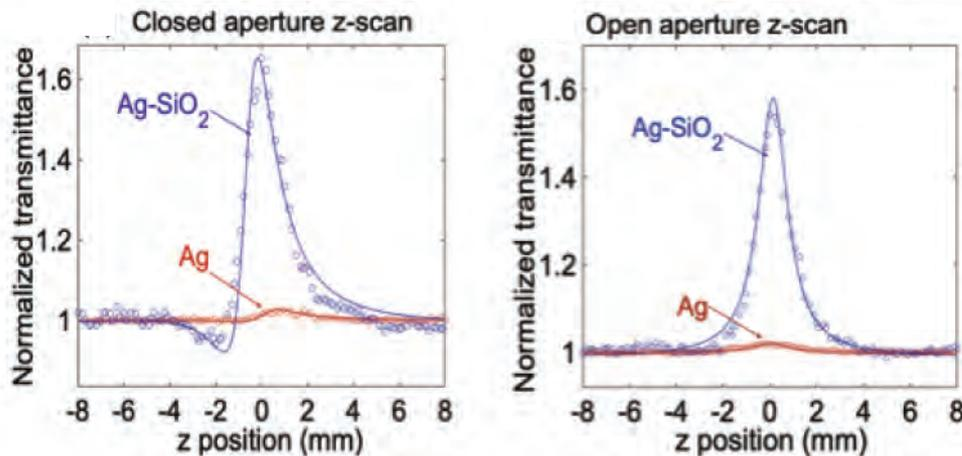

- Note the pronounced peak in the value of n_2 around the ENZ wavelength. We find a good but not perfect agreement with a simple effective medium theory.

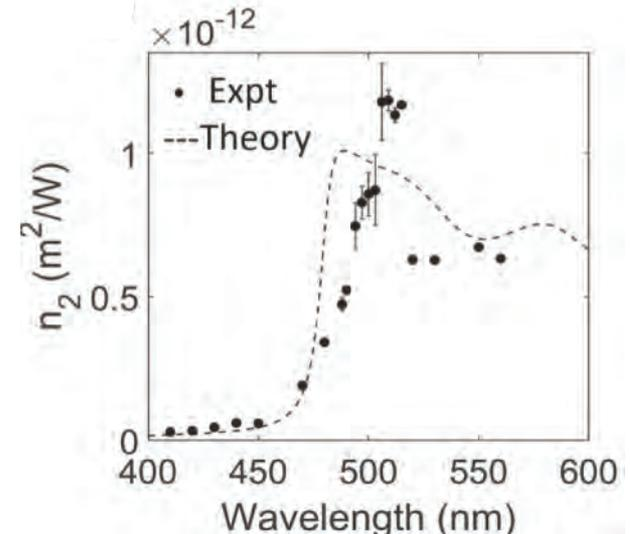

Quantum Imaging

- Goal of quantum imaging is to produce “better” images using quantum methods
 - image with a smaller number of photons
 - achieve better spatial resolution
 - achieve better signal-to-noise ratio
- Alternatively, quantum imaging exploits the quantum properties of the transverse structure of light fields

Single-Photon Coincidence Imaging (or rather Sorting)

How much information can be carried by a single photon?

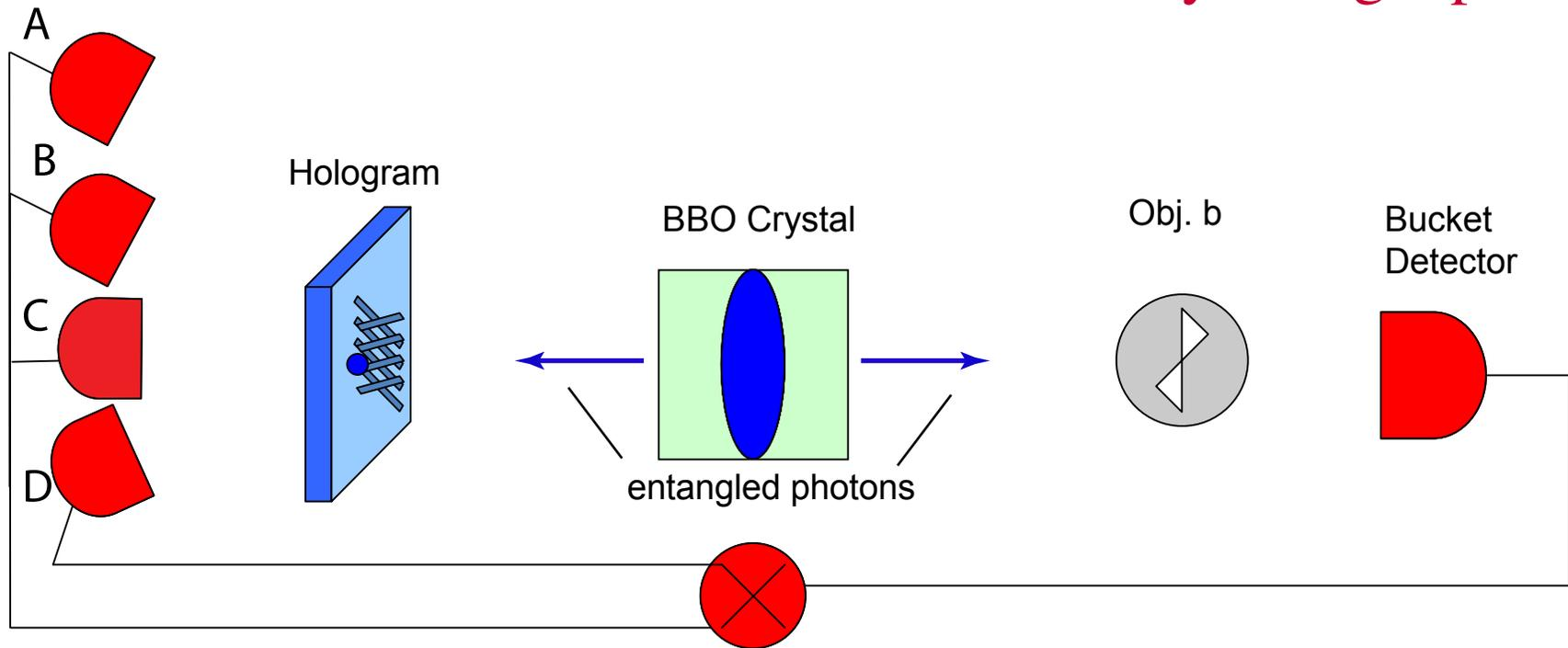

We discriminate among four orthogonal images using single-photon interrogation in a coincidence imaging configuration.

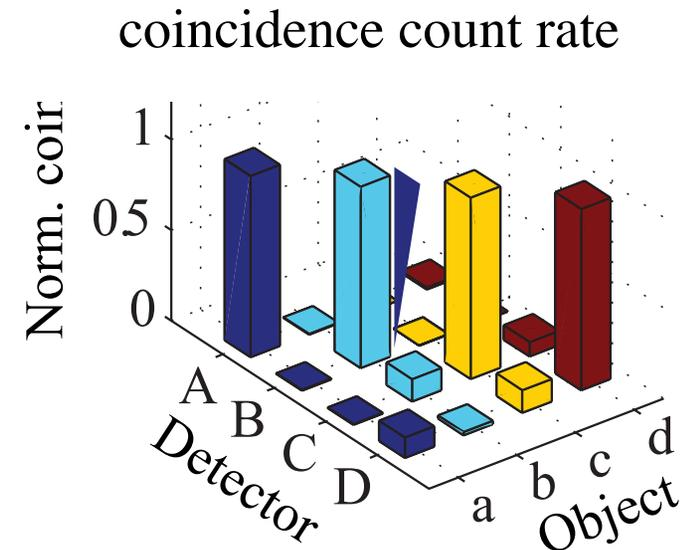
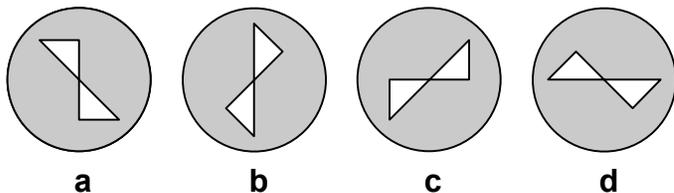

Quantum Lithography: Concept of Jonathan Dowling

- Entangled photons can be used to form an interference pattern with detail finer than the Rayleigh limit
- Resolution $\approx \lambda/2N$, where N = number of entangled photons

Boto et al., Phys. Rev. Lett. 85, 2733, 2000.

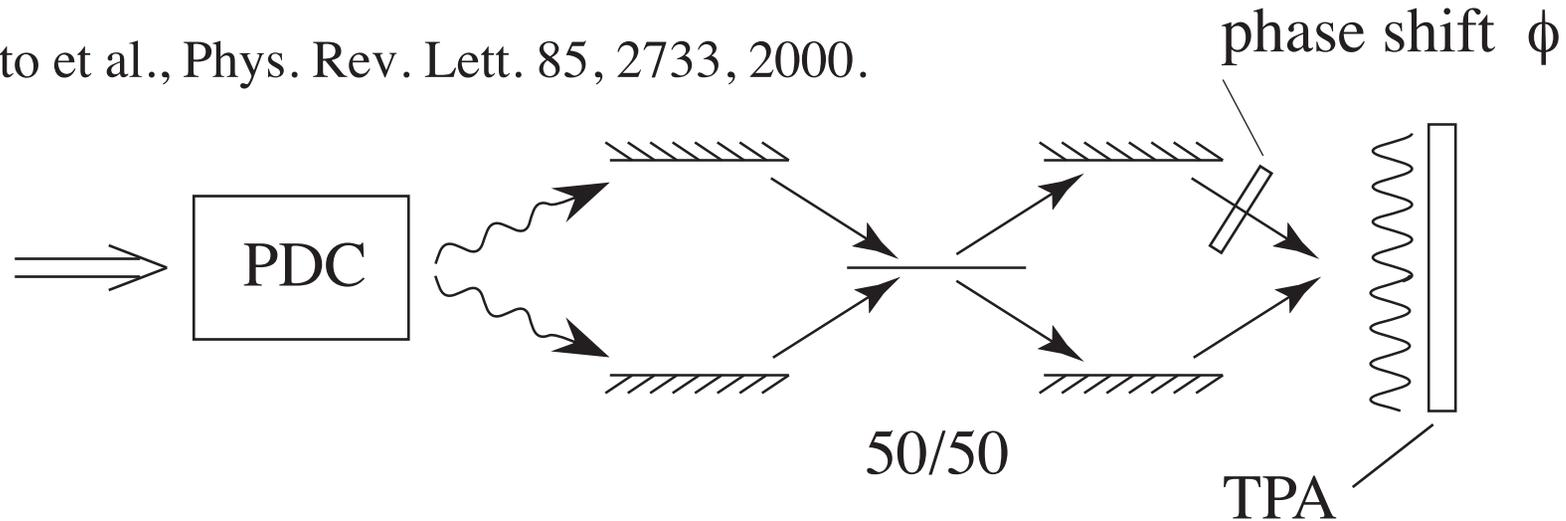

- No practical implementation to date, but some laboratory results

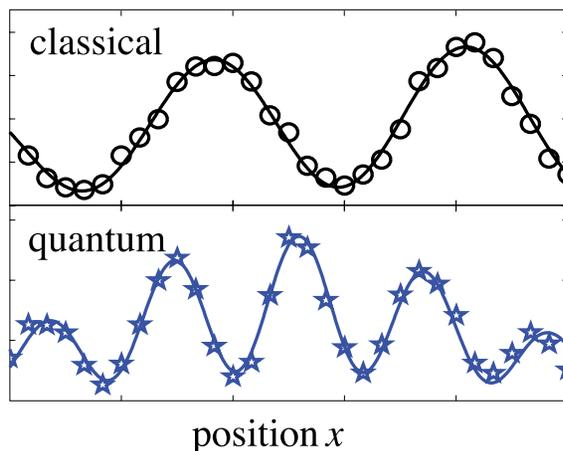

Quantum spatial superresolution by optical centroid measurements, Shin, Chan, Chang, and Boyd, Phys. Rev. Lett. 107, 083603 (2011).

See also, Quantum Lithography: Status of the Field, R.W. Boyd and J.P. Dowling, Quantum Information Processing, 11:891–901 (2012).

Optical Superresolution based on Entanglement

Entangled photons can be used to write (or read) an image showing increased spatial resolution

Demonstration for a simple interference pattern

Based on M. Tsang's optical centroid method (PRL, 2009)

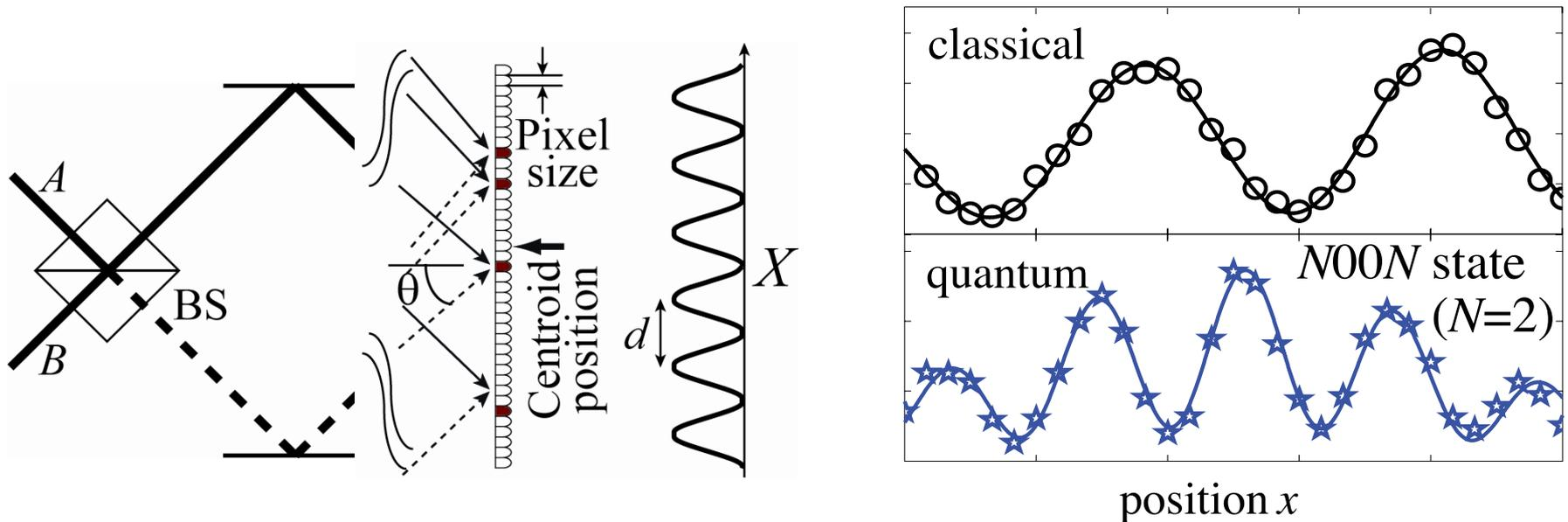

"S wcpwo /gpj cpegf "r j cug"ko ci kpi "y kj qw'eqkpekf gpeg"eqwpkpi

- Most biological materials provide phase structure but very little amplitude structure.

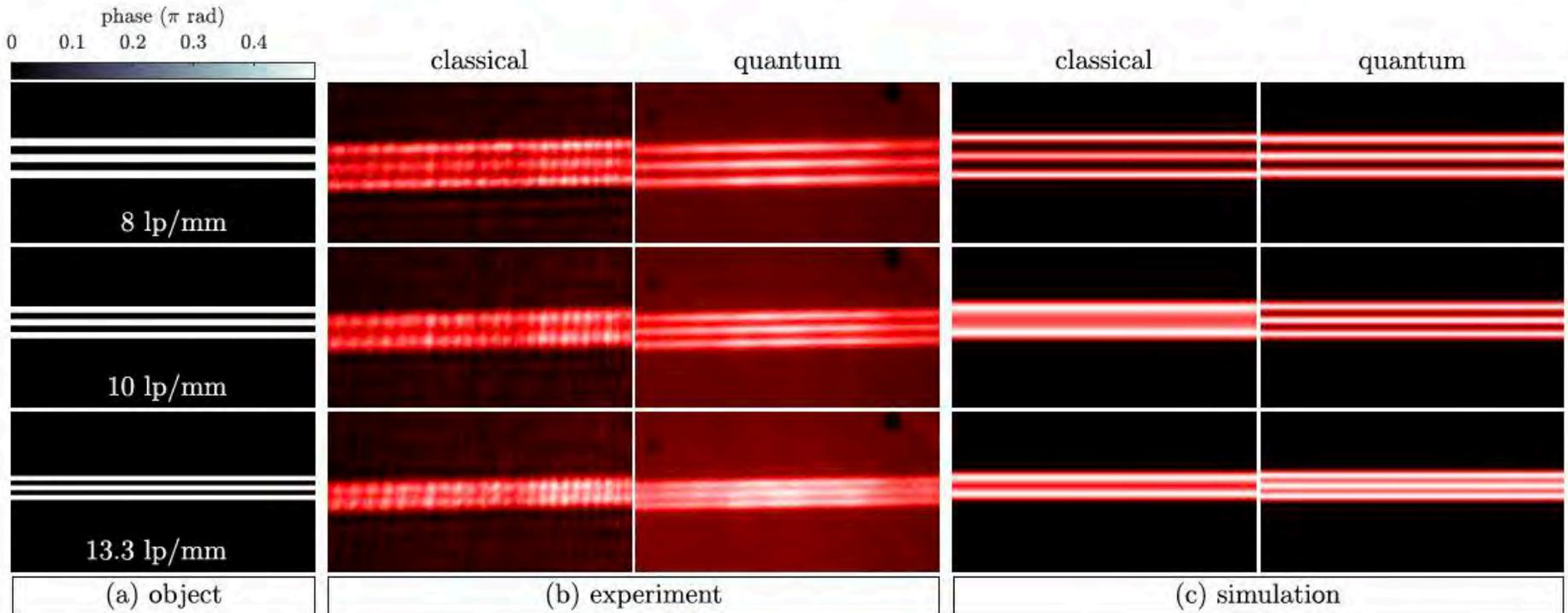
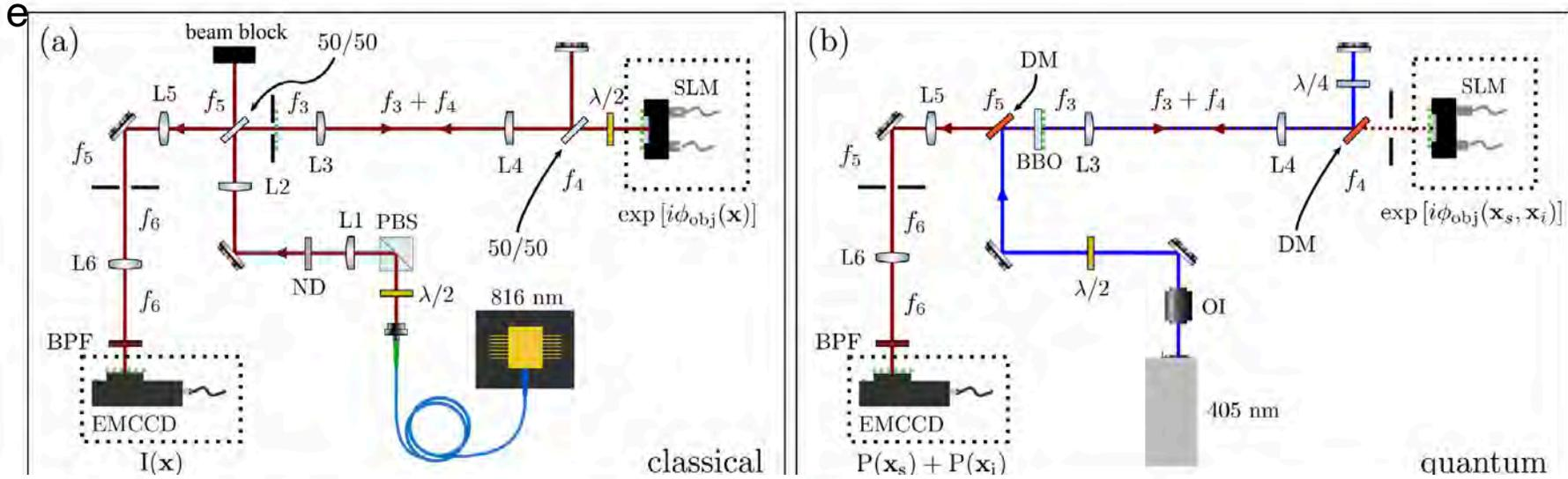

Superresolution

- What does quantum mechanics have to say about one's ability to achieve superresolution?
- And what is superresolution? We will take it to mean achieving spatial resolution in an optical imaging system that exceeds the Rayleigh or Abbe criterion.

- Rayleigh criterion: the angular separation of two stars must be greater than $1.22 \lambda / D$, where D is the diameter of the collecting aperture.

Resolved

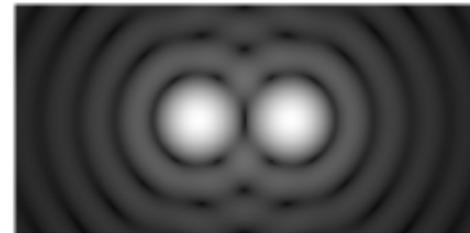

At limit of resolution

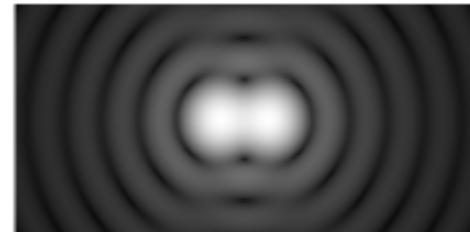

Not resolved

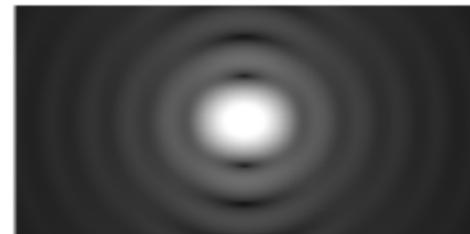

Mode Decomposition and Imaging

1. It is most natural to perform imaging in coordinate space, that is to measure the intensity $I(x)$ as a function of position.
2. However, one can alternatively describe an image by decomposing it into any complete, orthogonal basis set, such as the Hermite-Gauss (HG) or Laguerre-Gauss (LG) modes.
3. There are advantages to describing images in terms of a mode decomposition
 - (a) often a small number of parameters can characterize an image
 - (b) techniques exist for characterizing and manipulating LG and HG modes
 - (c) the mode decomposition can be used for superresolution, as proposed by Mankei Tsang

Quantum-limited estimation of the axial separation of two incoherent point sources

YIYU ZHOU,^{1,*} JING YANG,² JEREMY D. HASSETT,¹ SEYED MOHAMMAD HASHEMI RAFSANJANI,³ MOHAMMAD MIRHOSSEINI,⁴ A. NICK VAMIVAKAS,^{1,2,5} ANDREW N. JORDAN,^{2,6} ZHIMIN SHI,^{7,9} AND ROBERT W. BOYD^{1,2,8,10}

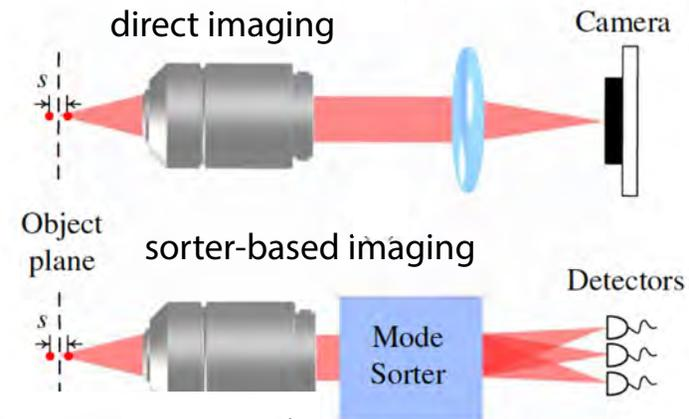

• Theory

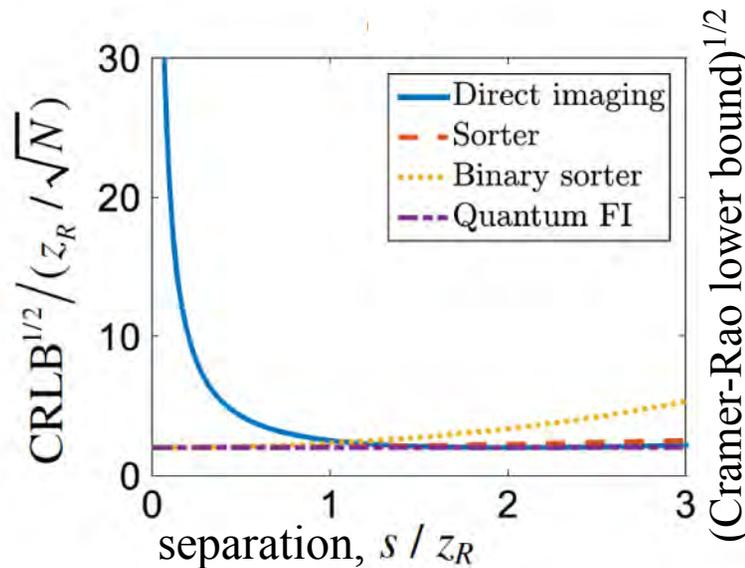
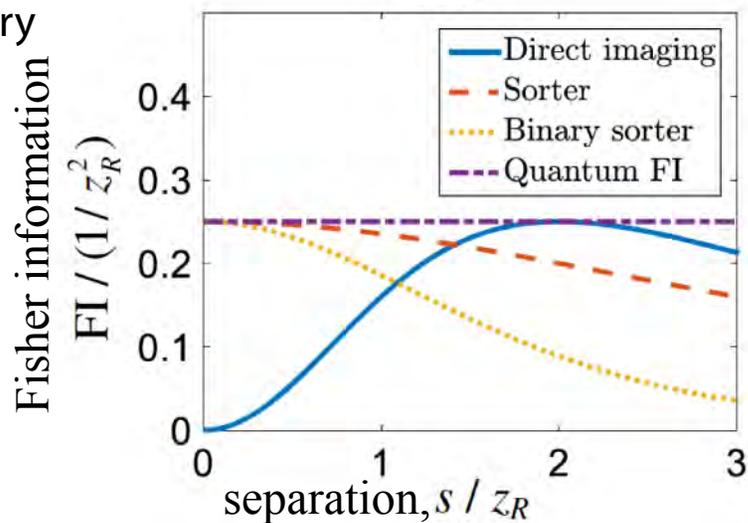

• Laboratory:

We use a binary sorter:

- Even-order radial modes go to one port and odd-order modes to the other port.

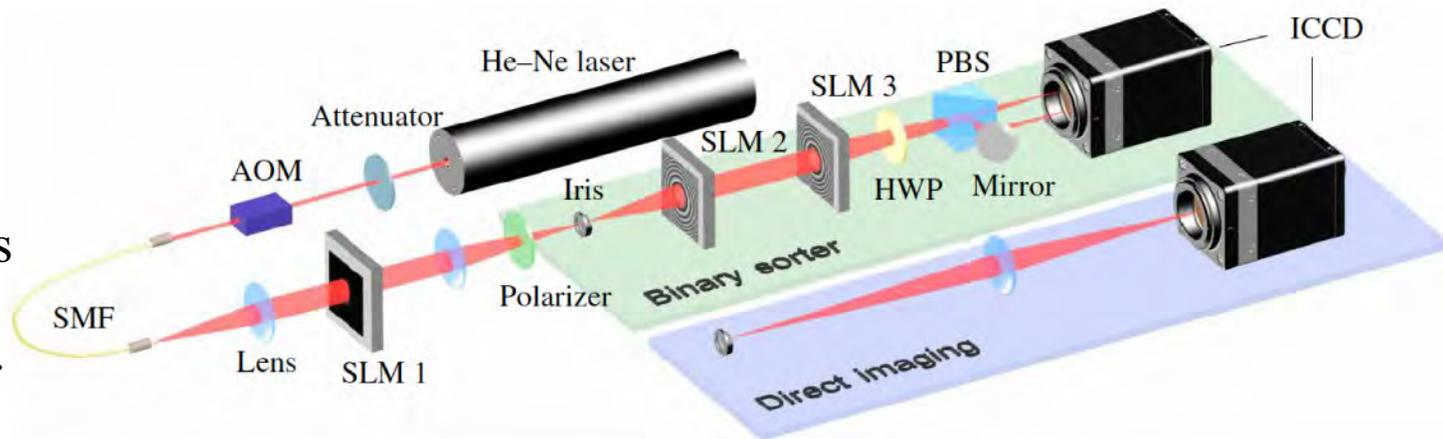

Can Tsang's method be used to increase the sharpness of more complicated (natural) images?



Research Article

Vol. 29, No. 8 / 12 April 2021 / Optics Express 11784

Optics EXPRESS

Confocal super-resolution microscopy based on a spatial mode sorter

KATHERINE K. M. BEARNE,^{1,7} YIYU ZHOU,^{2,7,*}  BORIS BRAVERMAN,¹  JING YANG,³ S. A. WADOOD,²  ANDREW N. JORDAN,^{3,4} A. N. VAMIVAKAS,^{2,3,5} ZHIMIN SHI,⁶ AND ROBERT W. BOYD^{1,2,3} 

¹Department of Physics, University of Ottawa, Ottawa, Ontario K1N 6N5, Canada

²The Institute of Optics, University of Rochester, Rochester, New York 14627, USA

³Department of Physics and Astronomy, University of Rochester, Rochester, New York 14627, USA

⁴Institute for Quantum Studies, Chapman University, Orange, California 92866, USA

⁵Materials Science Program, University of Rochester, Rochester, New York 14627, USA

⁶Department of Physics, University of South Florida, Tampa, Florida 33620, USA

⁷These authors contributed equally

*yzhou62@ur.rochester.edu

Our Experimental Procedure

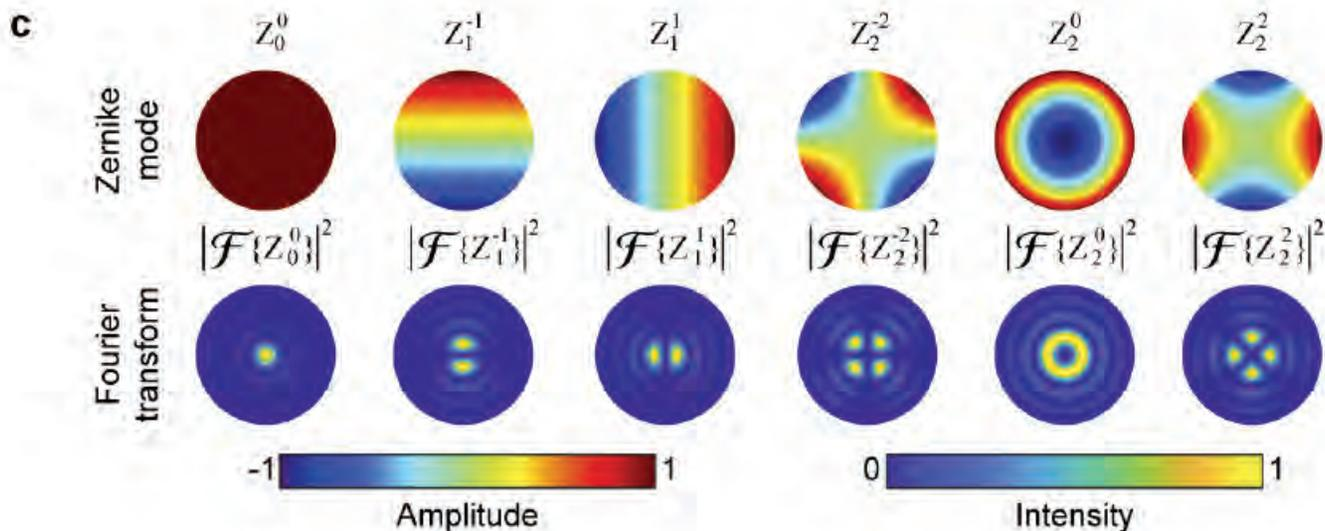
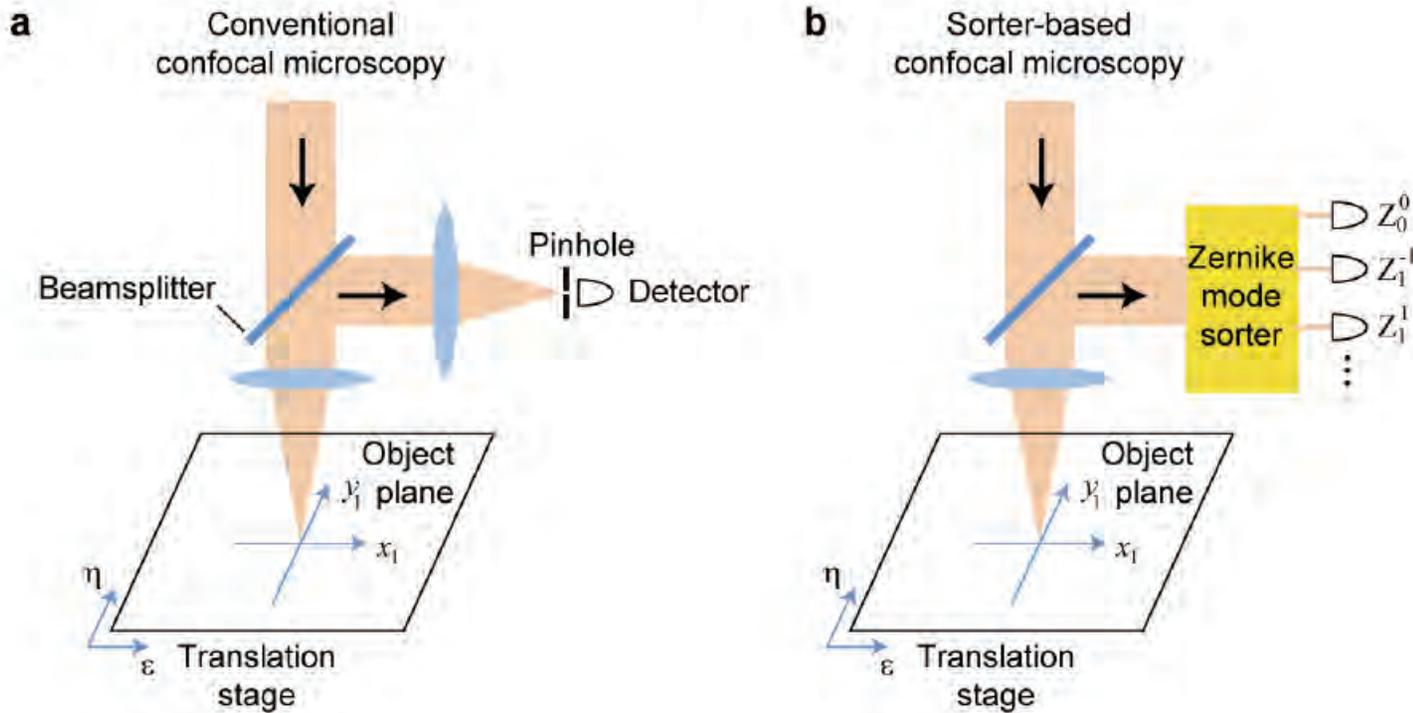

Some Experimental Results

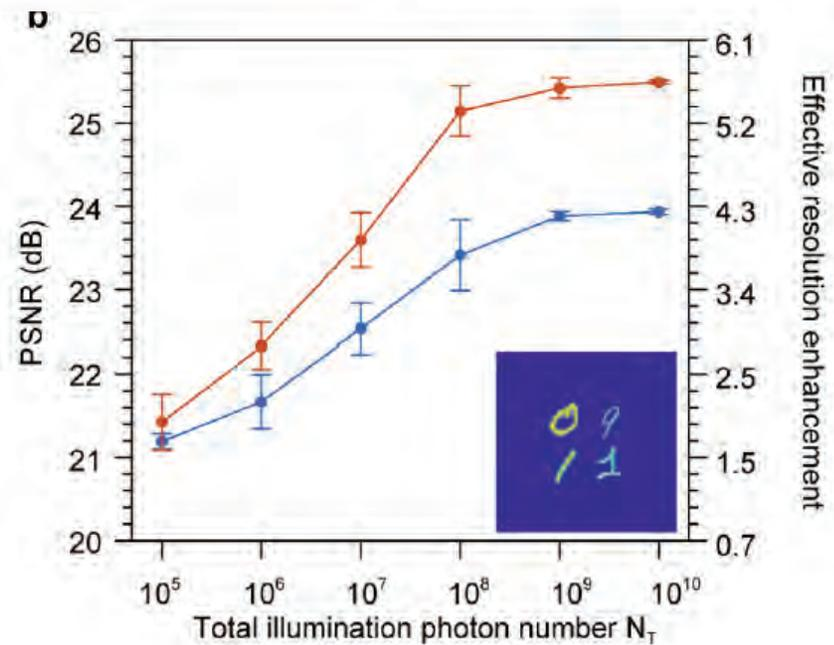
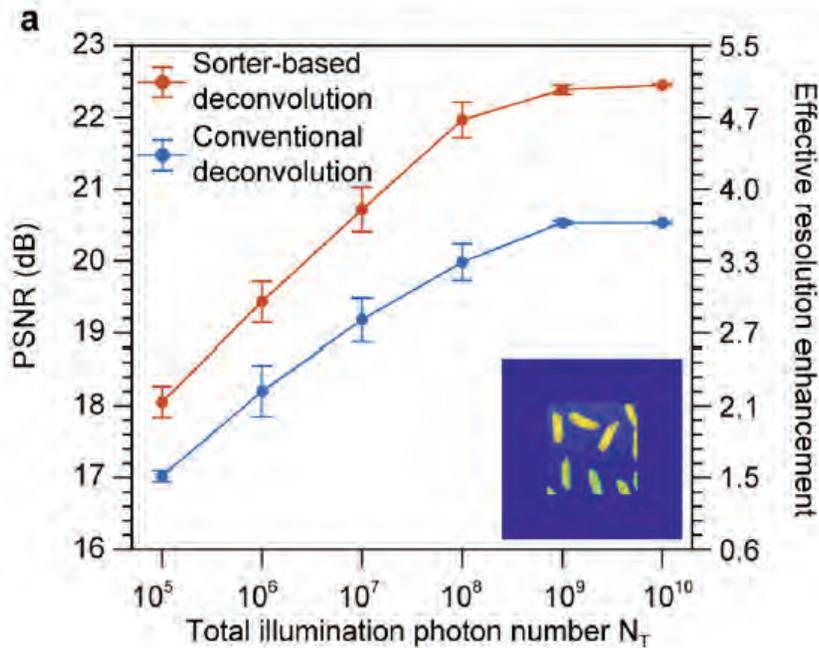
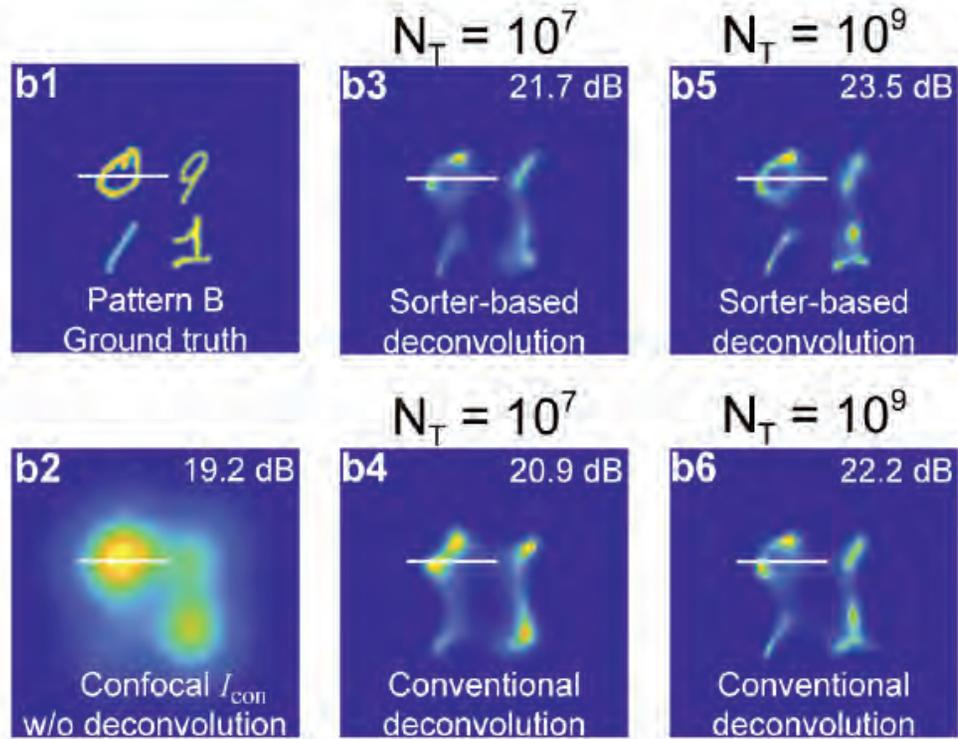

Ghost (Coincidence) Imaging

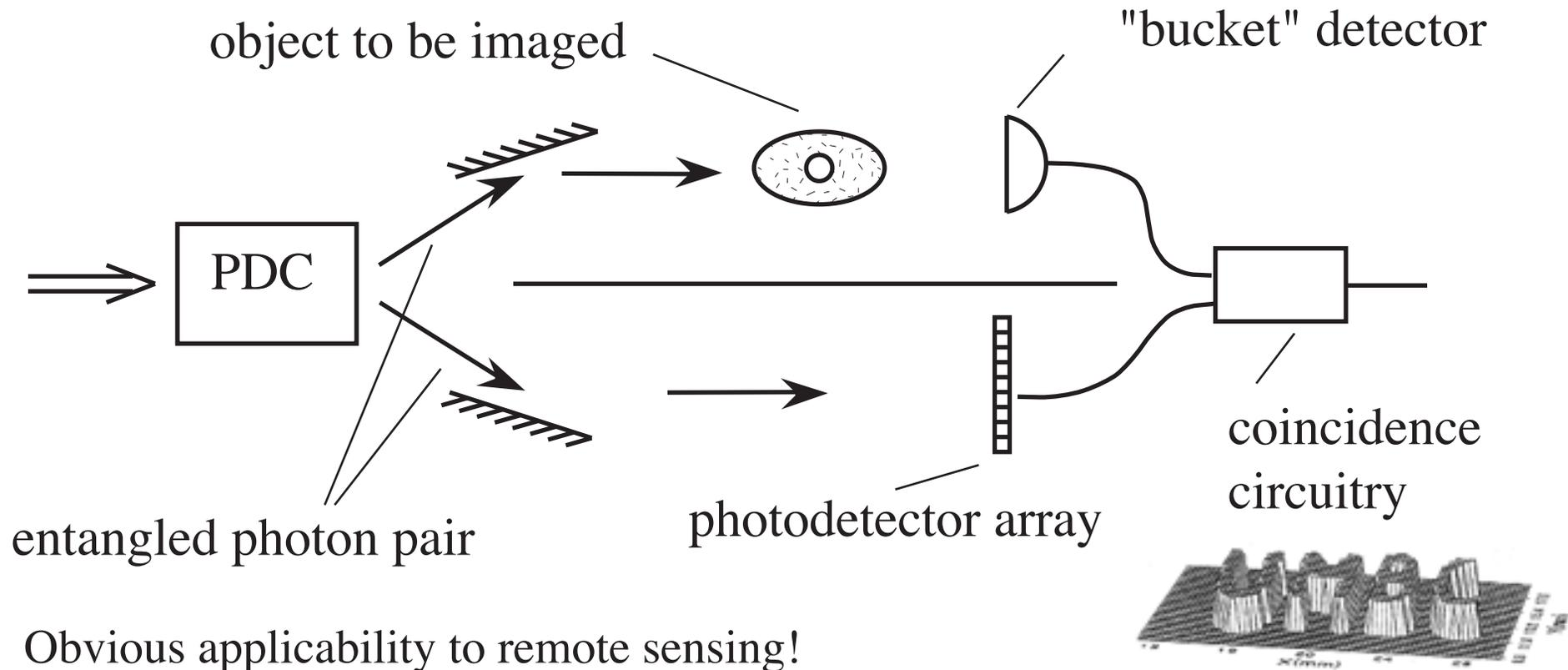

- Obvious applicability to remote sensing!
(imaging under adverse situations, bio, two-color, etc.)
- Is this a purely quantum mechanical process? (No)
- Can Brown-Twiss intensity correlations lead to ghost imaging? (Yes)

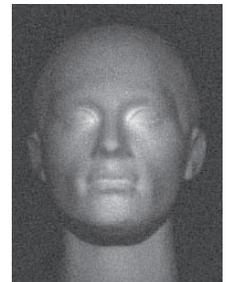

Strekalov et al., Phys. Rev. Lett. 74, 3600 (1995).

Pittman et al., Phys. Rev. A 52 R3429 (1995).

Abouraddy et al., Phys. Rev. Lett. 87, 123602 (2001).

Bennink, Bentley, and Boyd, Phys. Rev. Lett. 89 113601 (2002).

Bennink, Bentley, Boyd, and Howell, PRL 92 033601 (2004)

Gatti, Brambilla, and Lugiato, PRL 90 133603 (2003)

Gatti, Brambilla, Bache, and Lugiato, PRL 93 093602 (2003)

Padgett Group

Wavelength-Shifted (Two-Color) Ghost Microscopy

- Pump at 355 nm produces signal at 460 nm and idler at 1550 nm
- Object is illuminated at 1550 nm, but image is formed (in coincidence) at 460 nm
- Wavelength ratio of 3.4 is the largest yet reported.

Setup

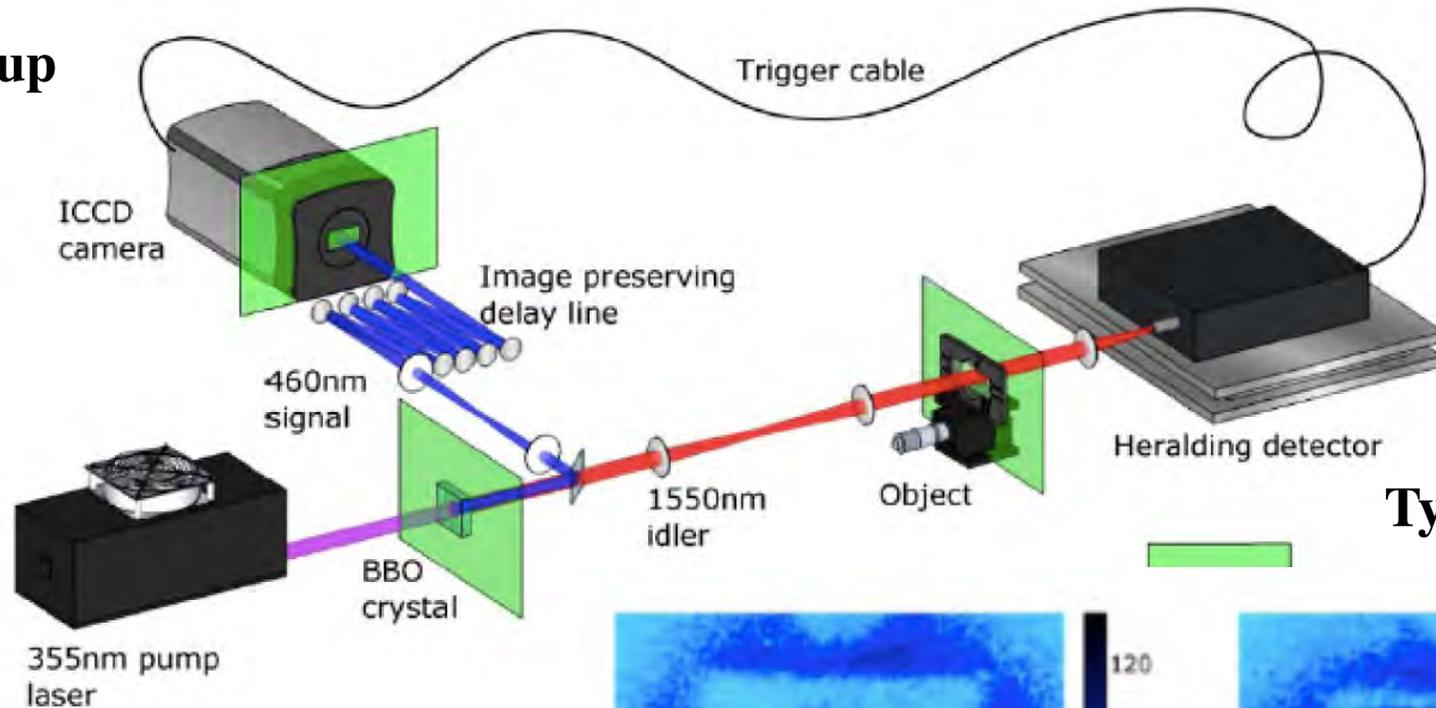

Typical images

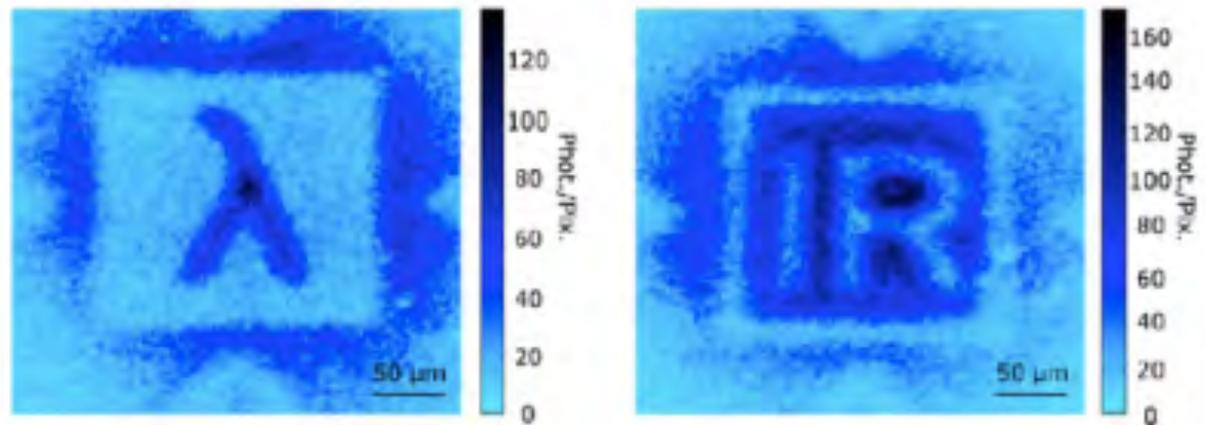

Two-Color Ghost Imaging, K.W.C. Chan, M.N. O'Sullivan, and R.W. Boyd, Phys. Rev. A 79, 033808 (2009).

Photon-sparse microscopy: visible light imaging using infrared illumination, Aspden, Boyd, Padgett, Optica 2, 1049 (2015).

Quantum Imaging by Interaction-Free Measurement

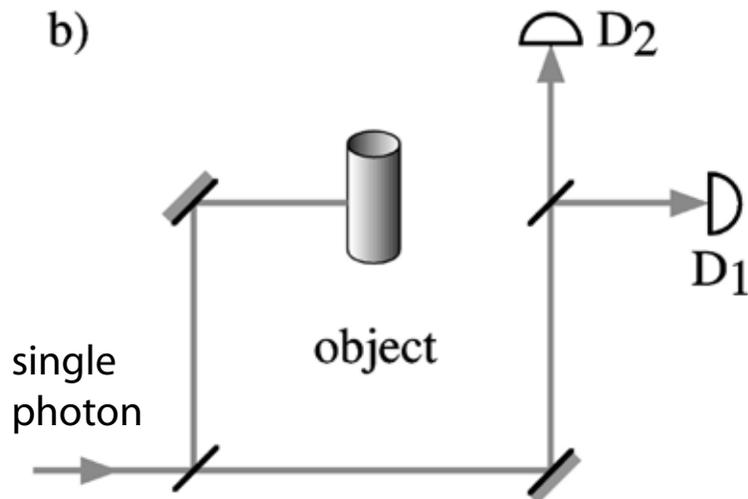
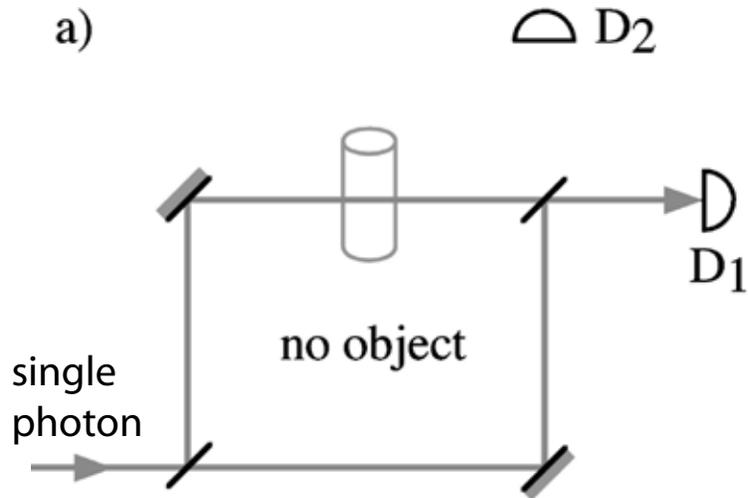

imaging setup

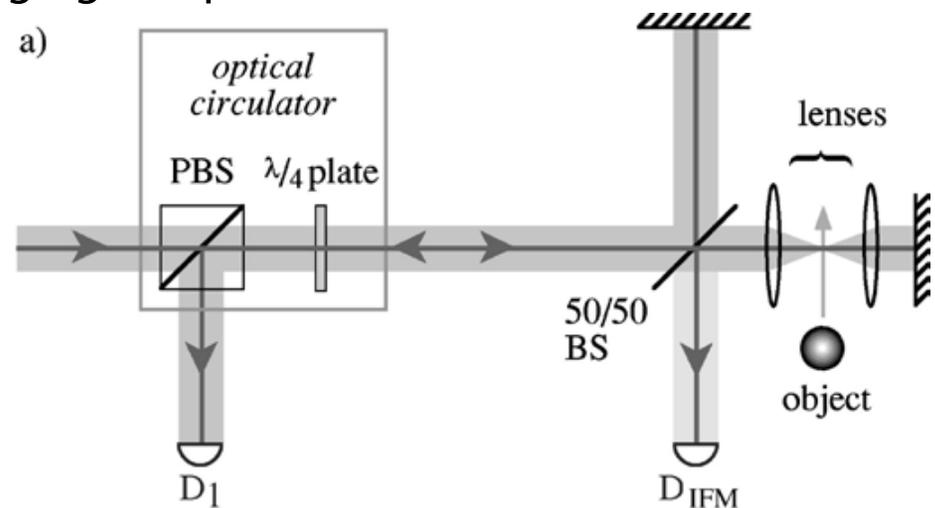

results

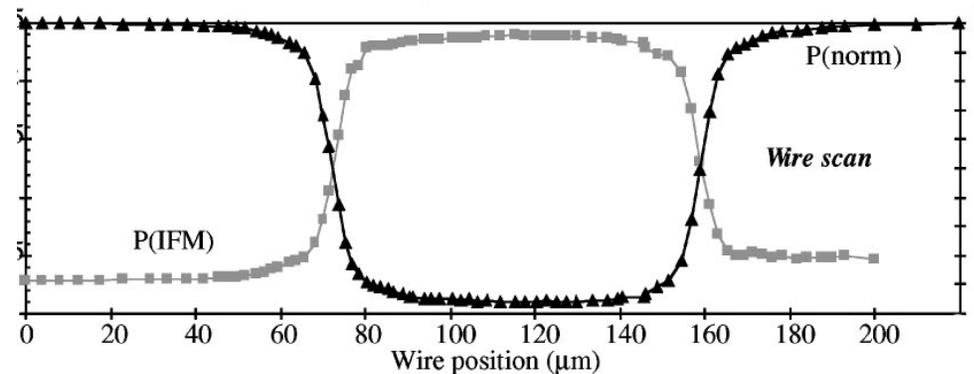

M. Renninger, Z. Phys. 15S, 417 (1960).

R. H. Dicke, Am. J. Phys. 49, 925 (1981).

A. Elitzur and L. Vaidman, Found. Phys. 23, 987 (1993).

L. Vaidman, Quant. Opt. 6, 119 (1994).

P. Kwiat, H. Weinfurter, T. Herzog, A. Zeilinger, and M. A. Kasevich, Phys. Rev. Lett. 74, 4763 (1995)

A. G. White, J. R. Mitchell, O. Nairz, and P. G. Kwiat, Phys. Rev. A 58, 605 (1998).

Interaction-Free Measurements and Entangled Photons

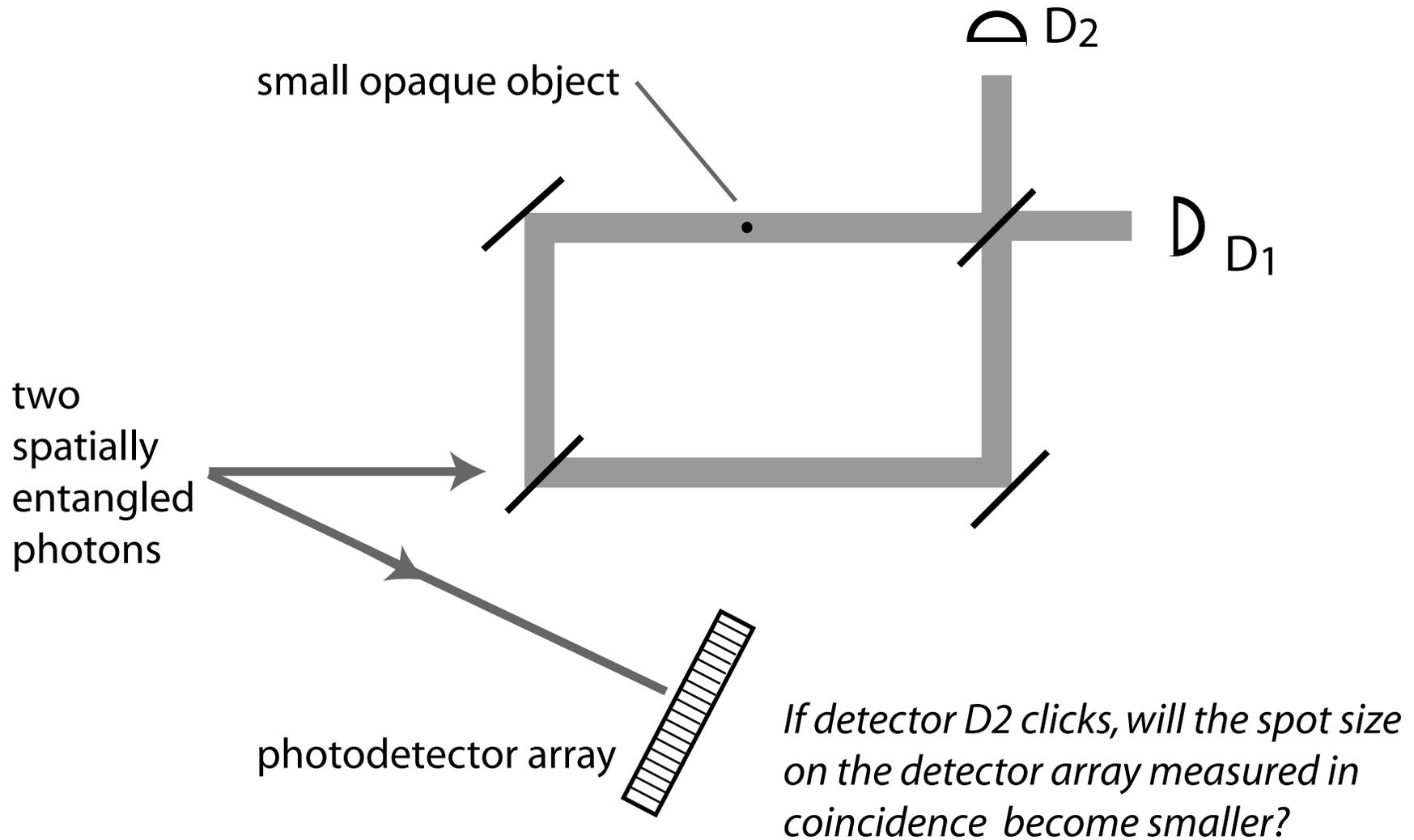

- Does an interaction-free measurement constitute a “real” measurement?
- Does it lead to the collapse of the wavefunction of its entangled partner?
- More precisely, does the entire two-photon wavefunction collapse?

Experimental Results

Interaction-free ghost image of a straight wire

coincidence counts

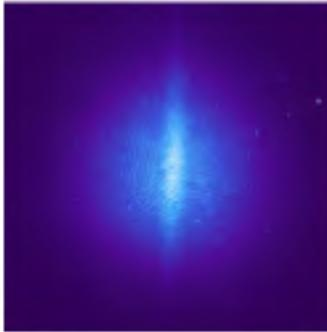

singles counts

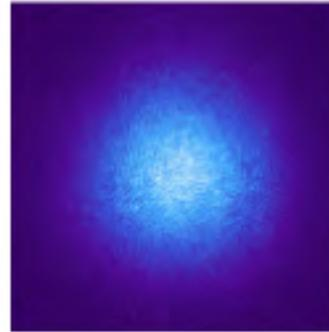

- Note that the interaction-free ghost image is about five times narrower than the full spot size on the ICCD camera
- This result shows that interaction-free measurements lead to wavefunction collapse, just like standard measurements.

Is interaction-free imaging useful?

Interaction-free imaging allows us to see what something looks like *in the dark!*

Could be extremely useful for biophysics. What does the retina look like when light does not hit it?

Boson Sampling

Boson sampling is a protocol for performing a restricted class of quantum computations by performing a quantum random walk.

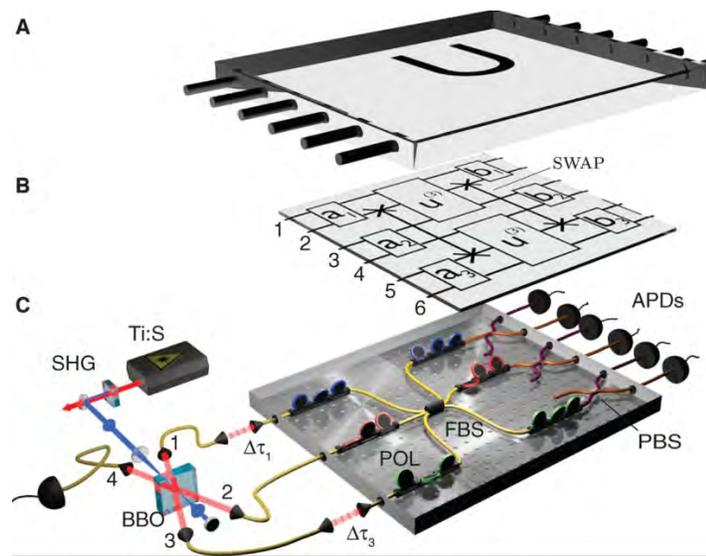
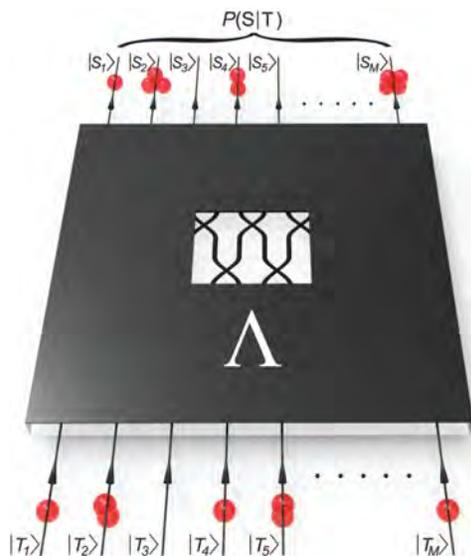

Broome et al., Photonic Boson Sampling in a tunable circuit, *Science*, 339, 794 (2012)

Spring et al., Boson Sampling on a photonic chip, *Science* 339, 798-801 (2012)

Franson, Beating Classical Computing Without a Quantum Computer, *Science* 339 767 (2013)

Single-Photon Sources

- Many protocols in quantum information require a single-photon source
- An example is the BB84 protocol of quantum key distribution
 - If by accident two photons were sent, one could be stolen by an eavesdropper - Even in a weak coherent state, there is a nonvanishing probability of two or more photons being sent
- Circularly polarized fluorescence and antibunching from a nanocrystal quantum dot doped into a glassy cholesteric liquid crystal microcavity

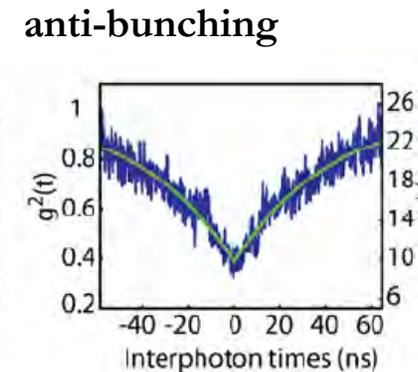
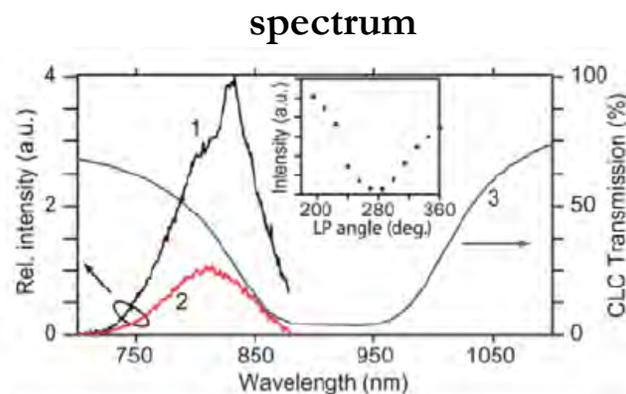
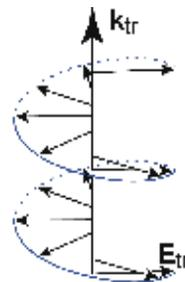
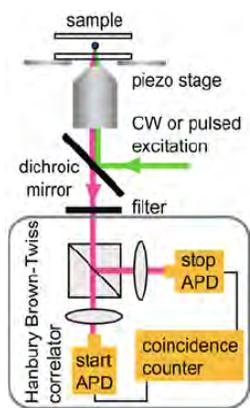

Lukishova et al., Journal of Physics: Conference Series 594 (2015) 012005

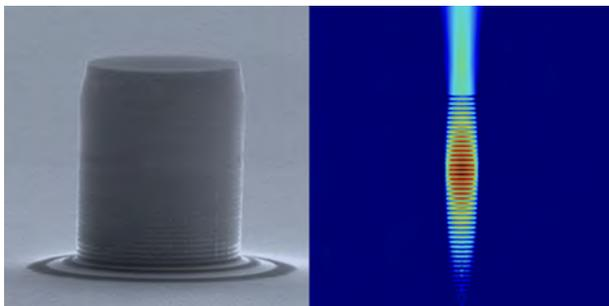

- J.-W. Pan Group, On-Demand Single Photons with High Extraction Efficiency and Near-Unity Indistinguishability from a Resonantly Driven Quantum Dot in a Micropillar, Phys. Rev. Lett. 116, 020401 (2016)

Special Thanks To My Students and Postdocs!

Ottawa Group



Rochester Group

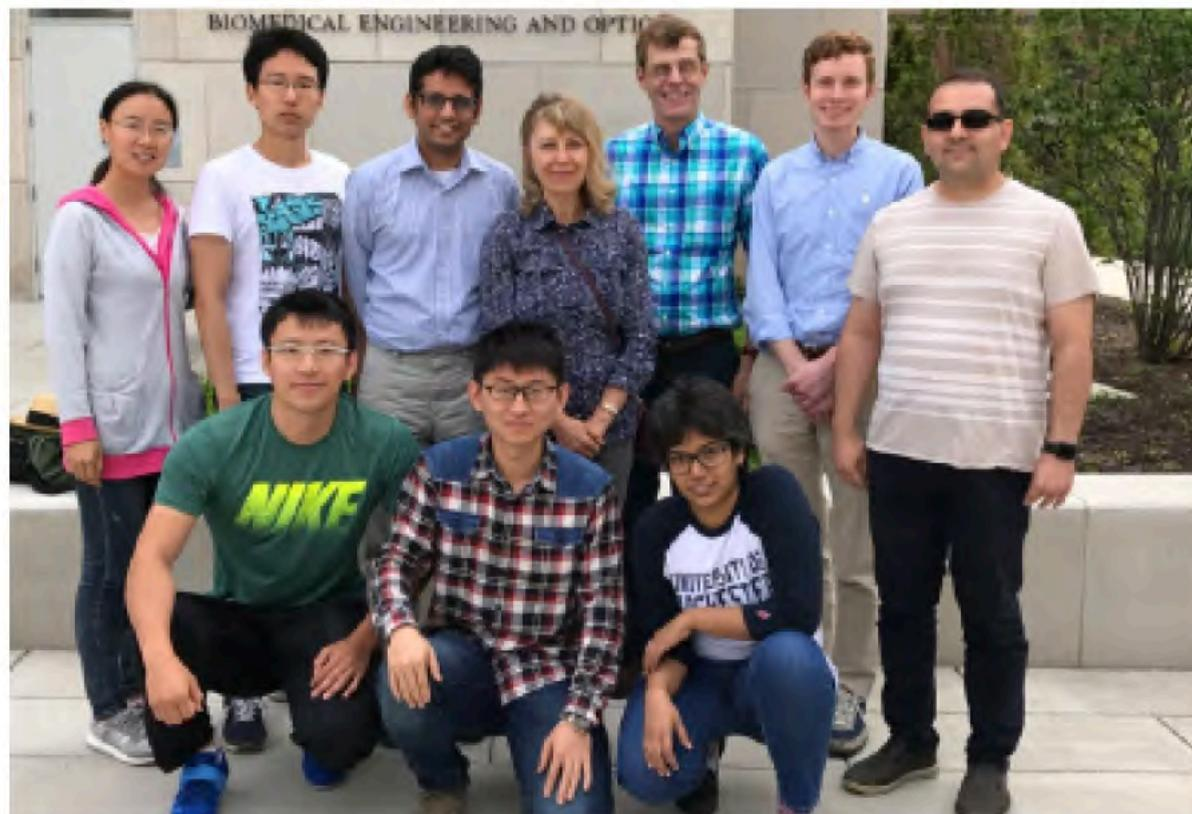

Quantum Protocols – Robert Boyd – University of Rochester

Quantum communication with many bits per photon

- Encode in light fields such as the Laguerre-Gauss OAM modes that possess an infinite-dimensional state space
- We use a seven-dimensional state space and transmit 2.1 bits per detected photon

• Lab Setup

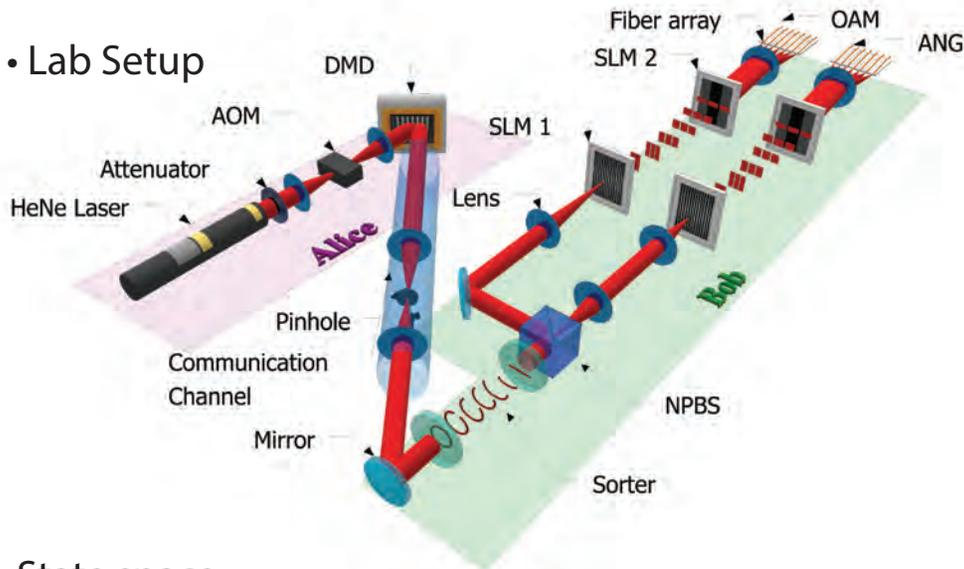

• State space

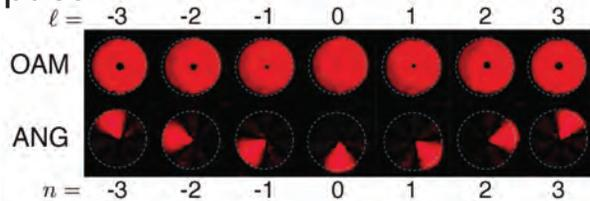

• Sample transmission

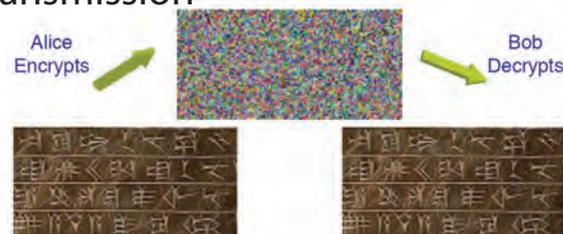

Mirhosseini et al, New J. Physics 7, 033033 (2015)

Quantum aberration correction

- Can we use a wavefront corrector in the idler path to compensate for aberrations in the signal path?

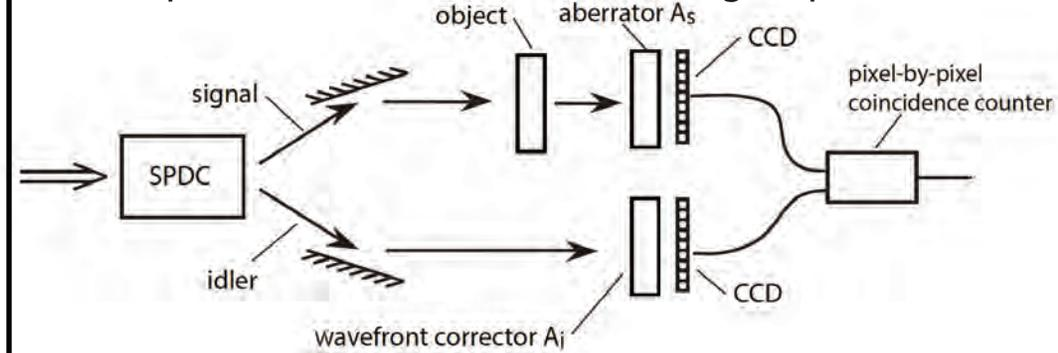

• Coincidence count rates

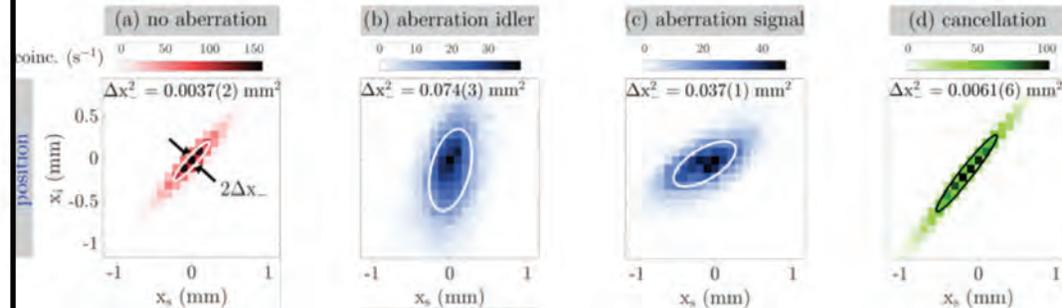

• Image of a double slit

(Black et al., Phys. Rev. Lett 123, 143603, 2019)

